

# Flavour



**Flavour è una cucina contemporanea che grazie alle diverse tipologie di ante e alle molteplici finiture può essere interpretata seguendo stili diversi. In questo modo le cucine Flavour cambiano aspetto a seconda dell'ambiente assumendo un mood classico o moderno.**

Flavour is a contemporary kitchen able to follow different styles, thanks to the different types of doors and the various finishes. In this way, the compositions of Flavour model change their appearance depending on the environment, taking on a classic or modern way.

**Il modello Flavour è  
certificato  
GREENGUARD Gold  
per le sue strutture  
e le sue ante.**

**The Flavour model is  
GREENGUARD Gold  
certified for all the  
carcasses and doors.**



# Certificazioni GREENGUARD e vernici Low VOC

Le ante e le strutture del modello Flavour sono contraddistinte dalla Certificazione GREENGUARD e GREENGUARD Gold. I prodotti che hanno ottenuto questa Certificazione sono testati dai laboratori UL, per soddisfare gli standard più rigorosi in termini di livelli di emissione di composti organici volatili (COV) emessi da mobili, superfici e vernice oltre ad altre sostanze chimiche nocive negli ambienti interni, contribuendo a ridurre l'inquinamento dell'aria interna e il rischio di esposizione chimica.

La Certificazione GREENGUARD Gold include criteri aggiuntivi basati sull'impatto delle sostanze chimiche sulla salute umana e richiede che i livelli di emissioni dei prodotti siano accettabili per l'uso in ambienti come scuole o strutture sanitarie frequentati da una fascia sensibile di persone come bambini e anziani.

Inoltre tutte le vernici utilizzate per le ante laccate del modello Flavour sono Low VOC, prodotti che rispondono ad elevati standard di sicurezza. In particolare, tali vernici sono conformi al Regolamento REACH, non contengono sostanze pericolose come le sostanze CMR e SVHC, sono conformi agli standard di emissioni indoor COV (Composti Organici Volatili). L'accurata selezione delle materie prime è stata pensata con il preciso scopo di ridurre significativamente i rischi di manipolazione ed esposizione per l'operatore e l'utilizzatore finale.

## GREENGUARD Certifications and Low VOC paints

The doors and carcasses of the Flavour model are GREENGUARD and GREENGUARD Gold Certified. The products that have achieved this Certification are tested by the UL laboratories in order to meet some of the world's most stringent standards in terms of volatile organic compounds (VOC) emissions from furniture products, surfaces and paint, as well as other harmful chemicals in indoor environments, helping to reduce indoor air pollution and the risk of chemical exposure.

The GREENGUARD Gold Certification includes additional criteria based on the impact of chemicals on human health and requires that the total VOC (volatile organic compounds) emission limits are such as to help ensure that the products are acceptable for use in environments like schools and health facilities, frequented by a sensitive group of people such as children and the elderly.

In addition, all the paints used for the lacquered doors of the Flavour model are Low VOC, which means products meeting high safety standards. Specifically, these paints comply with the REACH Regulation, do not contain dangerous substances such as CMR and SVHC, and comply with indoor VOC (Volatile Organic Compounds) emissions standards.

We carefully selected the raw materials with the specific aim of significantly reducing the risks of handling and exposure for the operator and the final user.



## Caratteristiche Vernici Low VOC

Conformità al Regolamento REACH

Etichettatura A+ dimostra la qualità e il ridotto impatto ambientale che si ottiene utilizzando questi prodotti per la verniciatura di arredi domestici.

Conformità delle Emissioni indoor di COV (ambienti domestici)  
Emissioni indoor: Norma 16000-9

Soddisfano i requisiti del Dipartimento della sanità pubblica della California, Metodo standard per il test e la valutazione delle emissioni di sostanze chimiche organiche volatili

Conformi allo standard BIFMA X7.1 e ai crediti BIFMA e 3 7.6.1, 7.6.2 e 7.6.3.

### Low VOC paints features

Compliance with the REACH Regulation

A + labeling. It demonstrates the quality and the reduced environmental impact obtained by using these products for the painting of domestic furnishings.

Indoor VOC emissions compliance (domestic environments) Indoor emissions: Standard 16000-9

They comply with requirements of the state of California's Department of Public Health "Standard Method for the Testing and Evaluation of Volatile Organic Chemical Emissions"

Compliant with BIFMA X7.1 standard and BIFMA and credits e 3 7.6.1, 7.6.2 and 7.6.3.

## Anta quadrata con maniglia a gola

Square door with finger rail opening

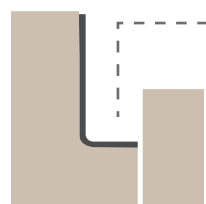

• gola tipo "elle"  
"L" type finger rail



## Anta con maniglia

Door with handle

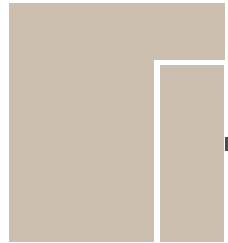

**FRONTALE**  
anta con  
maniglia  
frontale  
door with front  
handle



# Impiallacciata a telaio

SP. 24 MM

Neck  
Bridge

## CARATTERISTICHE TECNICHE

### ANTE E FRONTALI CASSETTI

telaio in massello di frassino laccato sp.24 mm con bugna in mdf certificato (conforme [US EPA TSCA Title VI](#))  
impiallacciata spazzolata a poro aperto tono su tono fiamma verticale nelle finiture: frassino grigio lava (opz.2447),  
frassino nebbia (opz.2449), frassino grigio reale (opz.2450), frassino bianco assoluto (opz.2466), frassino azzurro nube (opz.2467),  
frassino rosso persia (opz.2468), frassino nero seppia (opz.2469), frassino lino (opz.2470)

telaio in massello rovere tinto sp.24 mm con bugna in mdf certificato (conforme [US EPA TSCA Title VI](#))  
impiallacciata spazzolata a poro aperto, fiamma orizzontale nelle finiture: rovere nuvola (opz.5375), rovere calce (opz.5376),  
rovere mielato (opz.5377), rovere asfalto (opz.5378), rovere cuoio (opz.5379)

### ANTE VETRO

telaio in massello di frassino laccato sp.24 mm nelle finiture:  
frassino grigio lava (opz.2447), frassino nebbia (opz.2449), frassino grigio reale (opz.2450), frassino bianco assoluto (opz.2466),  
frassino azzurro nube (opz.2467), frassino rosso persia (opz.2468), frassino nero seppia (opz.2469), frassino lino (opz.2470)

telaio in massello rovere tinto sp.24 mm nelle finiture:  
rovere nuvola (opz.5375), rovere calce (opz.5376), rovere mielato (opz.5377), rovere asfalto (opz.5378), rovere cuoio (opz.5379)

con vetro: extrachiaro (opz.CH), fumè (opz.FM), bronzo (opz.BZ),  
extrachiaro serigrafato bianco trama nido d'ape (opz.CHN), fumè serigrafato bianco trama nido d'ape (opz.FMN),  
bronzo serigrafato bianco trama nido d'ape (opz.BZN)

### ANTE VETRO INGLESINA

telaio in massello di frassino laccato sp.24 mm con inglesina nelle finiture:  
frassino grigio lava (opz.2447I), frassino nebbia (opz.2449I), frassino grigio reale (opz.2450I), frassino bianco assoluto (opz.2466I),  
frassino azzurro nube (opz.2467I), frassino rosso persia (opz.2468I), frassino nero seppia (opz.2469I), frassino lino (opz.2470I)

telaio in massello rovere tinto sp.24 mm con inglesina nelle finiture:  
rovere nuvola (opz.5375I), rovere calce (opz.5376I), rovere mielato (opz.5377I), rovere asfalto (opz.5378I), rovere cuoio (opz.5379I)

con vetro: extrachiaro (opz.CH), fumè (opz.FM), bronzo (opz.BZ)  
[disponibili nelle misure: 71,7x44,7 - 71,7x59,7 - 107,7x44,7 - 107,7x59,7 - 203,7x44,7 - 203,7x59,7](#)

### GOLE

[vedi pag.34-35](#)

### MANIGLIE

[vedi pag.40-41-42](#)

### STRUTTURE

**ANTE: rovere calce, rovere mielato**  
di serie : nobilitato conchiglia (opz.8910) schiena e ripiano conchiglia (opz.8910)

**ANTE: rovere nuvola, frassino grigio reale, frassino rosso persia, rovere cuoio, frassino lino**  
di serie : nobilitato visone (opz.948M) schiena e ripiano visone (opz.948M)

**ANTE: rovere asfalto, frassino grigio lava, frassino nero seppia**  
di serie : nobilitato lavagna (opz.9620) schiena e ripiano lavagna (opz.9620)

**ANTE: frassino bianco assoluto, frassino azzurro nube**  
di serie : nobilitato bianco (opz.001) schiena e ripiano bianco (opz.001)

**ANTA: frassino nebbia**  
di serie : nobilitato argilla (opz.9690) schiena e ripiano argilla (opz.9690)

a richiesta : nobilitato fango (opz.8860) schiena e ripiano fango (opz.8860)  
nobilitato lino effetto tela (opz.8920) schiena e ripiano conchiglia (opz.8910)

### MENSOLE

[vedi pag.44](#)

### ZOCCOLI

[vedi pag.43](#)



# Veneered with frame

TH. 24 MM

Neck  
Bridge

TELAIO IMPIALLACCIATO  
VENEERED FRAME

## TECHNICAL FEATURES

### DOORS AND DRAWER FRONTS

solid lacquered ash frame Th. 24 mm with certified MDF panel (conforming to [US EPA TSCA Title VI](#))  
open-pore brushed veneered, tone-on-tone with vertical flame, available in the following finishes: lava grey ash (opt.2447), fog ash (opt.2449), royal grey ash (opt.2450), absolute white ash (opt.2466), cloud blue ash (opt.2467), persia red ash (opt.2468), cuttlefish ink ash (opt.2469), linen ash (opt.2470)  
stained solid oak frame Th. 24 mm with certified MDF panel (conforming to [US EPA TSCA Title VI](#))  
open-pore brushed veneered, horizontal flame, available in the following finishes: cloud oak (opt.5375), lime oak (opt.5376), honey oak (opt.5377), asphalt oak (opt.5378), leather oak (opt.5379)

### GLASS DOORS

24 mm-thick lacquered solid ash frame in the following finishes:  
lava grey ash (opt.2447), fog ash (opt.2449), royal grey ash (opt.2450), absolute white ash (opt.2466), cloud blue ash (opt.2467), persia red ash (opt.2468), cuttlefish ink ash (opt.2469), linen ash (opt.2470)  
24 mm-thick veneered solid wood frame in the following finishes:  
cloud oak (opt.5375), lime oak (opt.5376), honey oak (opt.5377), asphalt oak (opt.5378), leather oak (opt.5379)  
with glass: extra-clear (opt.CH), tinted (opt.FM), bronze (opt.BZ),  
extra-clear white screen-printed with honeycomb pattern (opt.CHN), tinted white screen-printed with honeycomb pattern (opt.FMN),  
bronze screen-printed white with honeycomb pattern (opt.BZN)

### GLASS PANEL DOORS

24 mm-thick lacquered solid ash frame with glass panels in the following finishes:  
lava grey ash (opt.2447I), fog ash (opt.2449I), royal grey ash (opt.2450I), absolute white ash (opt.2466I), cloud blue ash (opt.2467I), persia red ash (opt.2468I), cuttlefish ink ash (opt.2469I), linen ash (opt.2470I)  
24 mm-thick veneered solid wood frame with glass panels in the following finishes:  
cloud oak (opt.5375I), lime oak (opt.5376I), honey oak (opt.5377I), asphalt oak (opt.5378I), leather oak (opt.5379I)  
with glass: extra-clear (opt.CH), tinted (opt.FM), bronze (opt.BZ)  
[available in the following sizes: 71,7x44,7 - 71,7x59,7 - 107,7x44,7 - 107,7x59,7 - 203,7x44,7 - 203,7x59,7](#)

### FINGER RAILS

[see page 34-35](#)

### HANDLES

[see page 40-41-42](#)

### CARCASSES

**DOORS: lime oak, honey oak**  
standard: melamine-coated seashell (opt.8910), seashell back and shelf (opt.8910)

**DOORS: cloud oak, royal grey ash, persia red ash, leather oak, linen ash**  
standard: melamine-coated mink (opt.948M), mink back and shelf (opt.948M)

**DOORS: asphalt oak, lava grey ash, cuttlefish ink ash**  
standard: melamine-coated slate grey (opt.9620), slate grey back and shelf (opt.9620)

**DOORS: absolute white ash, cloud blue ash**  
standard: melamine-coated white (opt.001), white back and shelf (opt.001)

**DOOR: fog ash**  
standard: melamine-coated clay (opt.9690), clay back and shelf (opt.9690)

on request: melamine-coated mud (opt.8860), mud back and shelf (opt.8860)  
melamine-coated linen with canvas effect (opt.8920), seashell back and shelf (opt.8910)

### SHELVES

[see page 44](#)

### PLINTHS

[see page 43](#)

SP. 24 MM TH. 24 MM

---

ante frassino laccato  
lacquered ash doors



frassino grigio reale  
(opz.2450)  
royal grey ash

frassino lino  
(opz.2470)  
linen ash

ante frassino laccato  
lacquered ash doors



frassino azzurro nube  
(opz.2467)  
cloud blue ash

frassino rosso persia  
(opz.2468)  
persia red ash

frassino nero seppia  
(opz.2469)  
cuttlefish ink ash



frassino grigio lava  
(opz.2447)  
lava grey ash

frassino nebbia (opz.2449)  
fog ash

frassino bianco assoluto  
(opz.2466)  
absolute white ash

Neck

Bridge

**N.B.: non disponibili per modulistica H 84 (zoccolo H 6)**

**Note: not available for H 84 modularity (H 6 plinth)**

Neck

Bridge



**SP. 24 MM TH. 24 MM**

---

ante rovere tinto  
stained oak doors

Neck

Bridge



rovere nuvola (opz.5375)  
cloud oak



rovere calce (opz.5376)  
lime oak



rovere cuoio (opz.5379)  
leather oak



rovere mielato (opz.5377)  
honey oak



rovere asfalto (opz.5378)  
asphalt oak

SP. 24 MM TH. 24 MM

Neck

Bridge

## ante vetro frassino laccato

lacquered ash glass doors

N.B.: per i colori delle ante vedi pag.12

Note: for the door colours see page 12



frassino nebbia (opz.2449),  
vetro extrachiaro (opz.CH)  
fog ash (opt.2449),  
extra-clear glass (opt.CH)



frassino nebbia (opz.2449),  
vetro fumè (opz.FM)  
fog ash (opt.2449),  
tinted glass (opt.FM)

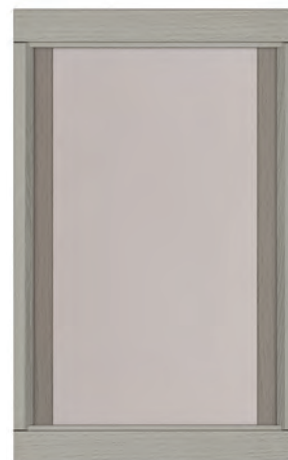

frassino nebbia (opz.2449),  
vetro bronzo (opz.BZ)  
fog ash (opt.2449),  
bronze glass (opt.BZ)



frassino nebbia (opz.2449),  
vetro extrachiaro serigrafato  
bianco, trama nido d'ape (opz.CHN)  
fog ash (opt.2449),  
ultra-clear screen-printed white glass  
with honeycomb pattern (opt.CHN)

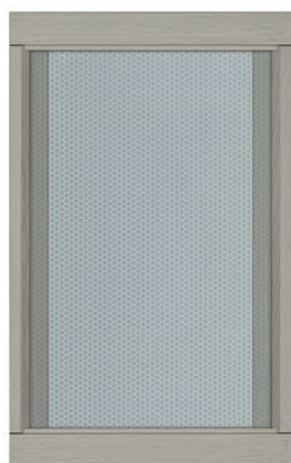

frassino nebbia (opz.2449),  
vetro fumè serigrafato  
bianco, trama nido d'ape (opz.FMN)  
fog ash (opt.2449),  
tinted screen-printed white glass with  
honeycomb pattern (opt.FMN)

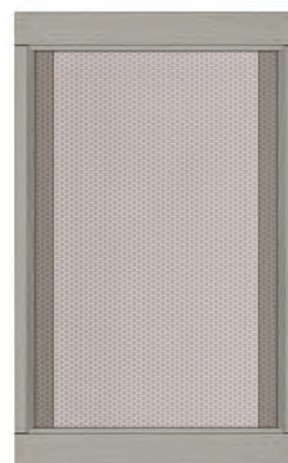

frassino nebbia (opz.2449),  
vetro bronzo serigrafato  
bianco, trama nido d'ape (opz.BZN)  
fog ash (opt.2449),  
bronze screen-printed white glass  
with honeycomb pattern (opt.BZN)

## ante vetro inglesina frassino laccato N.B.: PER I COLORI DELLE ANTE VEDI PAG.12

ash lacquered glass panel doors Note: for the door colours see page 12



frassino nebbia (opz.2449I),  
vetro extrachiaro (opz.CH)  
fog ash (opt.2449I),  
extra-clear glass (opt.CH)



frassino nebbia (opz.2449I),  
vetro fumè (opz.FM)  
fog ash (opt.2449I),  
tinted glass (opt.FM)



frassino nebbia (opz.2449I),  
vetro bronzo (opz.BZ)  
fog ash (opt.2449I),  
bronze glass (opt.BZ)

SP. 24 MM TH. 24 MM

Neck

ante vetro rovere tinto  
stained oak glass doors

Bridge

N.B.: per i colori delle ante vedi pag.13  
Note: for the door colours see page 13



rovere nuvola (opt.5375),  
vetro extrachiaro (opt.CH)  
cloud oak (opt.5375),  
extra-clear glass (opt.CH)



rovere nuvola (opt.5375),  
vetro fumè (opt.FM)  
cloud oak (opt.5375),  
tinted glass (opt.FM)



rovere nuvola (opt.5375),  
vetro bronzo (opt.BZ)  
cloud oak (opt.5375),  
bronze glass (opt.BZ)



rovere nuvola (opt.5375),  
vetro extrachiaro serigrafato  
bianco, trama nido d'ape (opt.CHN)  
cloud oak (opt.5375),  
ultra-clear screen-printed white glass  
with honeycomb pattern (opt.CHN)

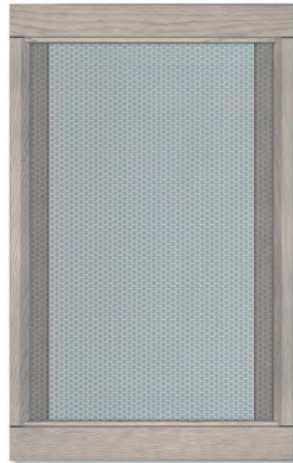

rovere nuvola (opt.5375),  
vetro fumè serigrafato  
bianco, trama nido d'ape (opt.FMN)  
cloud oak (opt.5375),  
tinted screen-printed white glass  
with honeycomb pattern (opt.FMN)

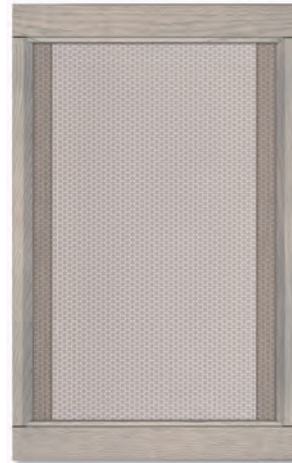

rovere nuvola (opt.5375),  
vetro bronzo serigrafato  
bianco, trama nido d'ape (opt.BZN)  
cloud oak (opt.5375),  
bronze screen-printed white glass  
with honeycomb pattern (opt.BZN)

ante vetro inglesina rovere tinto N.B.: PER I COLORI DELLE ANTE VEDI PAG.13  
stained oak glass panel doors Note: for the door colours see page 13



rovere mielato (opt.5377I),  
vetro extrachiaro (opt.CH)  
honey oak (opt.5377I),  
extra-clear glass (opt.CH)



rovere mielato (opt.5377I),  
vetro fumè (opt.FM)  
honey oak (opt.5377I),  
tinted glass (opt.FM)



rovere mielato (opt.5377I),  
vetro bronzo (opt.BZ)  
honey oak (opt.5377I),  
bronze glass (opt.BZ)

# Telaio laccata opaca soft

SP. 24 MM

Neck  
Bridge

## CARATTERISTICHE TECNICHE

### ANTE E FRONTALI CASSETTI

anta telaio sp.24 mm ricavata da pannello pantografato unico in mdf certificato (conforme [US EPA TSCA Title VI](#)) laccata opaca soft **\*"LOW VOC"** nei colori:

[CLICCA QUI PER LA GAMMA COLORI DISPONIBILI](#)

### ANTE VETRO

telaio in massello di tiglio sp.24 mm laccato opaco soft retro opaco **\*"LOW VOC"** nelle finiture:

[CLICCA QUI PER LA GAMMA COLORI DISPONIBILI](#)

con vetro: extrachiaro (opz.CH), fumè (opz.FM), bronzo (opz.BZ),  
extrachiaro serigrafato bianco trama nido d'ape (opz.CHN), fumè serigrafato bianco trama nido d'ape (opz.FMN),  
bronzo serigrafato bianco trama nido d'ape (opz.BZN)

### ANTE VETRO INGLESINA

telaio in massello di tiglio sp.24 mm con inglesina laccato opaco soft retro opaco **\*"LOW VOC"** nelle finiture:

[CLICCA QUI PER LA GAMMA COLORI DISPONIBILI](#)

con vetro: extrachiaro (opz.CH), fumè (opz.FM), bronzo (opz.BZ)  
disponibili nelle misure: 71,7x44,7 - 71,7x59,7 - 107,7x44,7 - 107,7x59,7 - 203,7x44,7 - 203,7x59,7

### GOLE

[vedi pag.34-35](#)

### MANIGLIE

[vedi pag.40-41-42](#)

### STRUTTURE

di serie : nobilitato bianco (opz.001) schiena e ripiano bianco (opz.001)

a richiesta : nobilitato fango (opz.8860) schiena e ripiano fango (opz.8860)  
nobilitato conchiglia (opz.8910) schiena e ripiano conchiglia (opz.8910)  
nobilitato visone (opz.948M) schiena e ripiano visone (opz.948M)  
nobilitato lavagna (opz.9620) schiena e ripiano lavagna (opz.9620)  
nobilitato argilla (opz.9690) schiena e ripiano argilla (opz.9690)  
nobilitato lino effetto tela (opz.8920) schiena e ripiano conchiglia (opz.8910)



### MENSOLE

[vedi pag.44](#)

### ZOCCOLI

[vedi pag.43](#)

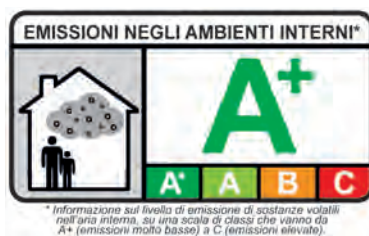

\* LE ANTE LACCATE SONO CONTRADDISTINTE DALL'UTILIZZO DI VERNICI CHE RISPONDONO AD ELEVATI STANDARD DI SICUREZZA. IN PARTICOLARE SONO CONFORMI AL REGOLAMENTO REACH, NON CONTENGONO PERTANTO PRODOTTI CHIMICAMENTE CONSIDERATI PERICOLOSI COME LE SOSTANZE CMR E SVHC (cancerogene, mutagene, tossiche). SONO CONFORMI AGLI STANDARD INTERNAZIONALI DI EMISSIONE INDOOR COV (composti organici volatili) ATTRAVERSO LA CERTIFICAZIONE GREENGUARD. TALE CERTIFICAZIONE INCLUDE CRITERI BASATI SULL'IMPATTO DELLE SOSTANZE CHIMICHE, SULLA SALUTE UMANA E RICHIEDE CHE I LIMITI DI EMISSIONE DEI COV TOTALI, SIANO TALI DA GARANTIRNE L'UTILIZZO ANCHE IN AMBIENTI CHE RICHIEDONO PARTICOLARI ESIGENZE COME SCUOLE E STRUTTURE SANITARIE.

# Soft matt lacquered frame

TH. 24 MM

Neck  
Bridge

## TECHNICAL FEATURES

### DOORS AND DRAWER FRONTS

24 mm-thick framed door derived from a single certified MDF pantographed panel (conforming to **US EPA TSCA Title VI**) soft matt lacquered **\*“LOW VOC”** available in the following colours:

[CLICK HERE FOR THE RANGE OF AVAILABLE COLORS](#)

### GLASS DOORS

24 mm-thick soft matt solid lime frame with matt rear **\*“LOW VOC”** available in the following finishes:

[CLICK HERE FOR THE RANGE OF AVAILABLE COLORS](#)

with glass: extra-clear (opt.CH), tinted (opt.FM), bronze (opt.BZ),  
extra-clear white screen-printed with honeycomb pattern (opt.CHN), tinted white screen-printed with honeycomb pattern (opt.FMN),  
bronze screen-printed white with honeycomb pattern (opt.BZN)

### GLASS PANEL DOORS

24 mm-thick soft matt solid lime frame with glass panels and matt rear **\*“LOW VOC”** available in the following finishes:

[CLICK HERE FOR THE RANGE OF AVAILABLE COLORS](#)

with glass: extra-clear (opt.CH), tinted (opt.FM), bronze (opt.BZ)  
available in the following sizes: 71,7x44,7 - 71,7x59,7 - 107,7x44,7 - 107,7x59,7 - 203,7x44,7 - 203,7x59,7

### FINGER RAILS

[see page 34-35](#)

### HANDLES

[see page 40-41-42](#)

### CARCASSES

**standard:** melamine-coated white (opt.001), white back and shelf (opt.001)

**on request:** melamine-coated mud (opt.8860), mud back and shelf (opt.8860)  
melamine-coated seashell (opt.8910), seashell back and shelf (opt.8910)  
melamine-coated mink (opt.948M), mink back and shelf (opt.948M)  
melamine-coated slate grey (opt.9620), slate grey back and shelf (opt.9620)  
melamine-coated clay (opt.9690), clay back and shelf (opt.9690)  
melamine-coated linen with canvas effect (opt.8920), seashell back and shelf (opt.8910)

### SHELVES

[see page 44](#)

### PLINTHS

[see page 43](#)

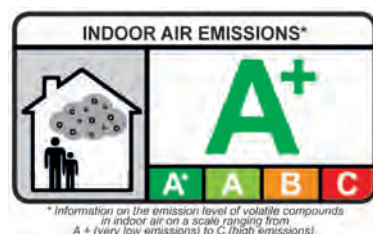

**\* THE LACQUERED DOORS ARE DISTINGUISHED BY THE USE OF PAINTS CONFORMING TO STRINGENT SAFETY STANDARDS. IN PARTICULAR, THEY CONFORM TO REACH SPECIFICATIONS AND ARE THEREFORE FREE OF CHEMICAL PRODUCTS REGARDED AS HAZARDOUS, SUCH AS CMR (carcinogenic, mutagenic, reprotoxic) SUBSTANCES AND SVHC. THEY CONFORM TO THE INTERNATIONAL STANDARDS FOR INDOOR VOC (volatile organic compounds) EMISSIONS THROUGH THE GREENGUARD CERTIFICATION. THIS CERTIFICATION INCLUDES CRITERIA BASED ON THE IMPACT OF CHEMICAL SUBSTANCES ON HUMAN HEALTH AND REQUIRES THAT THE LIMITS FOR TOTAL VOC EMISSIONS ARE ABLE TO GUARANTEE THEIR USE ALSO IN ENVIRONMENTS SUBJECT TO SPECIAL REQUIREMENTS, SUCH AS SCHOOLS AND HEALTHCARE FACILITIES.**

# Neck

# Bridge

SP. 24 MM TH. 24 MM

---

ante laccate opaco soft (N.B.:RETRO OPACO)

soft matt lacquered doors (NOTE: MATT REAR)



bianco assoluto  
(opz.740S)  
absolute white



grigio lava  
(opz.95F1)  
lava grey



nebbia  
(opz.95F5)  
fog



grigio reale  
(opz.95F3)  
royal grey



grigio quarzo  
(opz.95F7)  
quartz grey



lino  
(opz.9513)  
linen



conchiglia  
(opz.7403)  
seashell



creta  
(opz.9515)  
clay

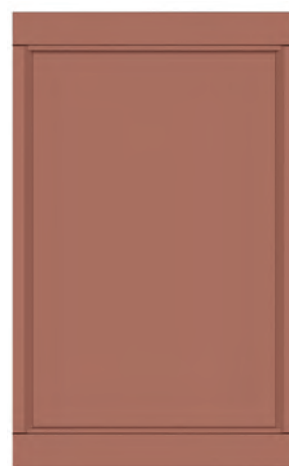

rosso persia  
(opz.8165)  
persia red



nero seppia  
(opz.7897)  
cuttlefish ink



azzurro nube  
(opz.8379)  
cloud blue

[CLICCA QUI PER LA GAMMA COLORI DISPONIBILI](#)

[CLICK HERE FOR THE RANGE OF AVAILABLE COLORS](#)

N.B.: ante disponibili anche in tutti i colori laccato opaco della tabella laccati Lube Cucine  
Note: doors are also available in all matt lacquer colours on the Lube Cucine colour chart

# Neck

# Bridge

SP. 24 MM TH. 24 MM

ante vetro laccate opaco soft **N.B.: PER I COLORI DELLE ANTE VEDI PAG.18**  
soft matt lacquered glass doors **Note: for the door colours see page 18**



creta (opz.9515), vetro extrachiaro (opz.CH)  
clay (opt.9515), ultra-clear glass (opt.CH)

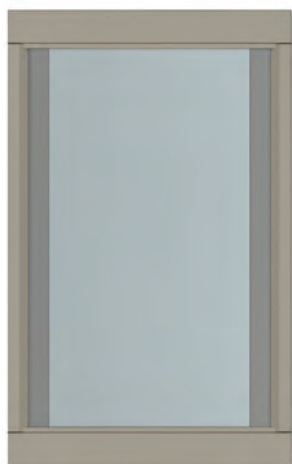

creta (opz.9515), vetro fumè (opz.FM)  
clay (opt.9515), tinted glass (opt.FM)

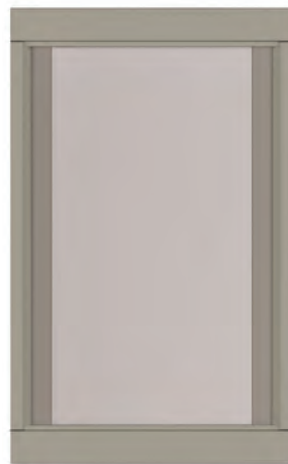

creta (opz.9515), vetro bronzo (opz.BZ)  
clay (opt.9515), bronze glass (opt.BZ)

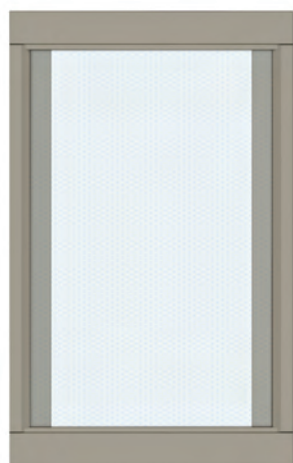

creta (opz.9515),  
vetro extrachiaro serigrafato  
bianco, trama nido d'ape (opz.CHN)  
clay (opt.9515),  
ultra-clear screen-printed white glass with  
honeycomb pattern (opt.CHN)

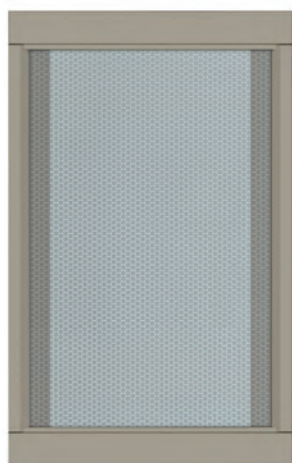

creta (opz.9515),  
vetro fumè serigrafato  
bianco, trama nido d'ape (opz.FMN)  
clay (opt.9515),  
tinted screen-printed white glass with  
honeycomb pattern (opt.FMN)



creta (opz.9515),  
vetro bronzo serigrafato  
bianco, trama nido d'ape (opz.BZN)  
clay (opt.9515),  
bronze screen-printed white glass with  
honeycomb pattern (opt.BZN)

ante vetro inglesina laccate opaco soft **N.B.: PER I COLORI DELLE ANTE VEDI PAG.18**  
soft matt lacquered glass panel doors **Note: for the door colours see page 18**



creta (opz.9515),vetro extrachiaro (opz.CH)  
clay (opt.9515),ultra-clear glass (opt.CH)



creta (opz.9515),vetro fumè (opz.FM)  
clay (opt.9515), tinted glass (opt.FM)



creta (opz.9515), vetro bronzo (opz.BZ)  
clay (opt.9515), bronze glass (opt.BZ)

# Telaio laccata lucida

SP. 24 MM

Neck  
Bridge

## CARATTERISTICHE TECNICHE

### ANTE E FRONTALI CASSETTI

anta telaio sp.24 mm ricavata da pannello pantografato unico in mdf certificato (conforme **US EPA TSCA Title VI**) laccata lucido diretto retro opaco **\*"LOW VOC"** nei colori:

[CLICCA QUI PER LA GAMMA COLORI DISPONIBILI](#)

### ANTE VETRO

telaio in massello di tiglio sp.24 mm laccata lucido diretto retro opaco **\*"LOW VOC"** nelle finiture:

[CLICCA QUI PER LA GAMMA COLORI DISPONIBILI](#)

con vetro: extrachiaro (opz.CH), fumè (opz.FM), bronzo (opz.BZ),  
extrachiaro serigrafato bianco trama nido d'ape (opz.CHN), fumè serigrafato bianco trama nido d'ape (opz.FMN),  
bronzo serigrafato bianco trama nido d'ape (opz.BZN)

### ANTE VETRO INGLESINA

telaio in massello di tiglio sp.24 mm con inglesina laccata lucido diretto retro opaco **\*"LOW VOC"** nelle finiture:

[CLICCA QUI PER LA GAMMA COLORI DISPONIBILI](#)

con vetro: extrachiaro (opz.CH), fumè (opz.FM), bronzo (opz.BZ)  
disponibili nelle misure: 71,7x44,7 - 71,7x59,7 - 107,7x44,7 - 107,7x59,7 - 203,7x44,7 - 203,7x59,7

### GOLE

vedi pag.34-35

### MANIGLIE

vedi pag.40-41-42

### STRUTTURE

di serie : nobilitato bianco (opz.001) schiena e ripiano bianco (opz.001)

a richiesta : nobilitato fango (opz.8860) schiena e ripiano fango (opz.8860)  
nobilitato conchiglia (opz.8910) schiena e ripiano conchiglia (opz.8910)  
nobilitato visone (opz.948M) schiena e ripiano visone (opz.948M)  
nobilitato lavagna (opz.9620) schiena e ripiano lavagna (opz.9620)  
nobilitato argilla (opz.9690) schiena e ripiano argilla (opz.9690)  
nobilitato lino effetto tela (opz.8920) schiena e ripiano conchiglia (opz.8910)



### MENSOLE

vedi pag.44

### ZOCCOLI

vedi pag.43

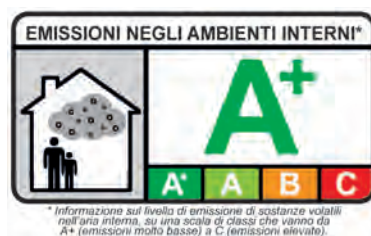

\* LE ANTE LACCATE SONO CONTRADDISTINTE DALL'UTILIZZO DI VERNICI CHE RISPONDONO AD ELEVATI STANDARD DI SICUREZZA. IN PARTICOLARE SONO CONFORMI AL REGOLAMENTO REACH, NON CONTENGONO PERTANTO PRODOTTI CHIMICAMENTE CONSIDERATI PERICOLOSI COME LE SOSTANZE CMR E SVHC (cancerogene, mutagene, tossiche). SONO CONFORMI AGLI STANDARD INTERNAZIONALI DI EMISSIONE INDOOR COV (composti organici volatili) ATTRAVERSO LA CERTIFICAZIONE GREENGUARD. TALE CERTIFICAZIONE INCLUDE CRITERI BASATI SULL'IMPATTO DELLE SOSTANZE CHIMICHE, SULLA SALUTE UMANA E RICHIEDE CHE I LIMITI DI EMISSIONE DEI COV TOTALI, SIANO TALI DA GARANTIRNE L'UTILIZZO ANCHE IN AMBIENTI CHE RICHIEDONO PARTICOLARI ESIGENZE COME SCUOLE E STRUTTURE SANITARIE.



# Glossy lacquered frame

TH. 24 MM

Neck  
Bridge

## TECHNICAL FEATURES

### DOORS AND DRAWER FRONTS

24 mm-thick framed door derived from a single certified MDF pantographed panel (conforming to **US EPA TSCA Title VI**) direct glossy lacquered with matt rear **\*“LOW VOC”** available in the following colours:

[CLICK HERE FOR THE RANGE OF AVAILABLE COLORS](#)

### GLASS DOORS

24 mm-thick glossy direct lacquered solid lime frame with matt rear **\*“LOW VOC”** available in the following finishes:

[CLICK HERE FOR THE RANGE OF AVAILABLE COLORS](#)

with glass: extra-clear (opt.CH), tinted (opt.FM), bronze (opt.BZ),  
extra-clear white screen-printed with honeycomb pattern (opt.CHN), tinted white screen-printed with honeycomb pattern (opt.FMN),  
bronze screen-printed white with honeycomb pattern (opt.BZN)

### GLASS DOORS DOORS

24 mm-thick direct glossy lacquered solid lime frame with glass panels and matt rear **\*“LOW VOC”** available in the following finishes:

[CLICK HERE FOR THE RANGE OF AVAILABLE COLORS](#)

with glass: extra-clear (opt.CH), tinted (opt.FM), bronze (opt.BZ)  
available in the following sizes: 71,7x44,7 - 71,7x59,7 - 107,7x44,7 - 107,7x59,7 - 203,7x44,7 - 203,7x59,7

### FINGER RAILS

[see page 34-35](#)

### HANDLES

[see page 40-41-42](#)

### CARCASSES

**standard:** melamine-coated white (opt.001), white back and shelf (opt.001)

**on request:** melamine-coated mud (opt.8860), mud back and shelf (opt.8860)  
melamine-coated seashell (opt.8910), seashell back and shelf (opt.8910)  
melamine-coated mink (opt.948M), mink back and shelf (opt.948M)  
melamine-coated slate grey (opt.9620), slate grey back and shelf (opt.9620)  
melamine-coated clay (opt.9690), clay back and shelf (opt.9690)  
melamine-coated linen with canvas effect (opt.8920), seashell back and shelf (opt.8910)

### SHELVES

[see page 44](#)

### PLINTHS

[see page 43](#)

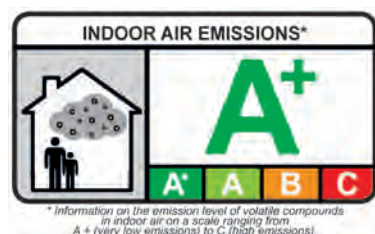

**\* THE LACQUERED DOORS ARE DISTINGUISHED BY THE USE OF PAINTS CONFORMING TO STRINGENT SAFETY STANDARDS. IN PARTICULAR, THEY CONFORM TO REACH SPECIFICATIONS AND ARE THEREFORE FREE OF CHEMICAL PRODUCTS REGARDED AS HAZARDOUS, SUCH AS CMR (carcinogenic, mutagenic, reprotoxic) SUBSTANCES AND SVHC. THEY CONFORM TO THE INTERNATIONAL STANDARDS FOR INDOOR VOC (volatile organic compounds) EMISSIONS THROUGH THE GREENGUARD CERTIFICATION. THIS CERTIFICATION INCLUDES CRITERIA BASED ON THE IMPACT OF CHEMICAL SUBSTANCES ON HUMAN HEALTH AND REQUIRES THAT THE LIMITS FOR TOTAL VOC EMISSIONS ARE ABLE TO GUARANTEE THEIR USE ALSO IN ENVIRONMENTS SUBJECT TO SPECIAL REQUIREMENTS, SUCH AS SCHOOLS AND HEALTHCARE FACILITIES.**

# Neck

# Bridge

SP. 24 MM TH. 24 MM

---

ante laccate lucide (N.B.:RETRO OPACO)  
glossy lacquered doors (NOTE: MATT REAR)



bianco assoluto  
(opz.741)  
absolute white



grigio lava  
(opz.95F2)  
lava grey



nebbia  
(opz.95F6)  
fog



grigio reale  
(opz.95F4)  
royal grey



grigio quarzo  
(opz.95F8)  
quartz grey



lino  
(opz.9514)  
linen

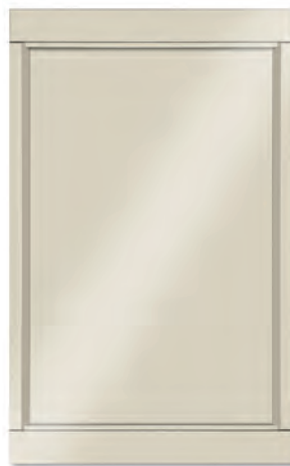

conchiglia  
(opz.7404)  
seashell



creta  
(opz.9516)  
clay

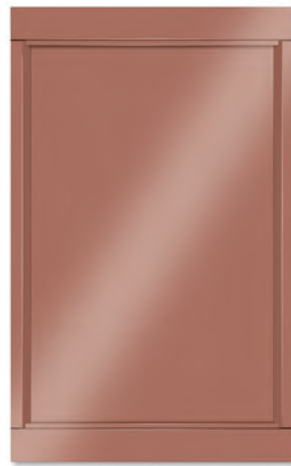

rosso persia  
(opz.8166)  
persia red



nero seppia  
(opz.7898)  
cuttlefish ink



azzurro nube  
(opz.8380)  
cloud blue

[CLICCA QUI PER LA GAMMA COLORI DISPONIBILI](#)

[CLICK HERE FOR THE RANGE OF AVAILABLE COLORS](#)

N.B.: ante disponibili anche in tutti i colori laccato lucido della tabella laccati Lube Cucine  
Note: doors are also available in all glossy lacquer colours on the Lube Cucine colour chart

# Neck

# Bridge

SP. 24 MM TH. 24 MM

ante vetro laccate lucide **N.B.: PER I COLORI DELLE ANTE VEDI PAG.22**

glossy lacquered glass doors **Note: for the door colours see page 22**



grigio quarzo (opz.95F8),  
vetro extrachiaro (opz.CH)  
quartz grey (opt.95F8),  
extra-clear glass (opt.CH)



grigio quarzo (opz.95F8),  
vetro fumè (opz.FM)  
quartz grey (opt.95F8),  
tinted glass (opt.FM)



grigio quarzo (opz.95F8),  
vetro bronzo (opz.BZ)  
quartz grey (opt.95F8),  
bronze glass (opt.BZ)



grigio quarzo (opz.95F8),  
vetro extrachiaro serigrafato  
bianco, trama nido d'ape (opz.CHN)  
quartz grey (opt.95F8),  
ultra-clear screen-printed white glass with  
honeycomb pattern (opt.CHN)

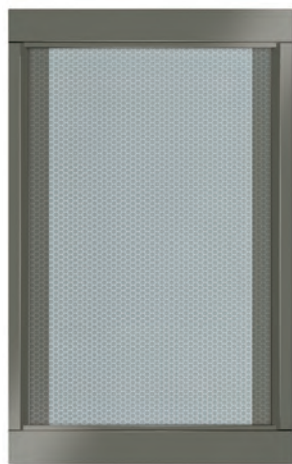

grigio quarzo (opz.95F8),  
vetro fumè serigrafato  
bianco, trama nido d'ape (opz.FMN)  
quartz grey (opt.95F8),  
tinted screen-printed white glass with  
honeycomb pattern (opt.FMN)

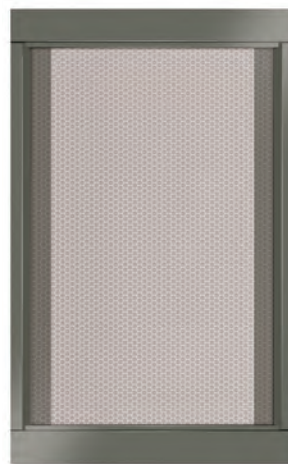

grigio quarzo (opz.95F8),  
vetro bronzo serigrafato  
bianco, trama nido d'ape (opz.BZN)  
quartz grey (opt.95F8),  
bronze screen-printed white glass with  
honeycomb pattern (opt.BZN)

ante vetro inglesina laccate lucide **N.B.: PER I COLORI DELLE ANTE VEDI PAG.22**

glossy lacquered glass panel doors **Note: for the door colours see page 22**



creta (opz.95F8I), vetro extrachiaro (opz.CH)  
clay (opt.95F8I), ultra-clear glass (opt.CH)

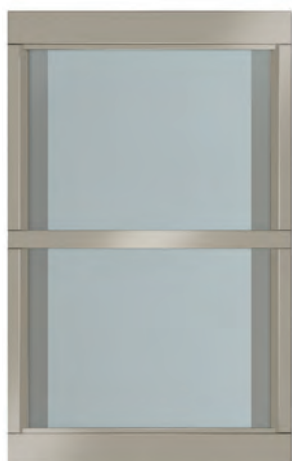

creta (opz.95F8I), vetro fumè (opz.FM)  
clay (opt.95F8I), tinted glass (opt.FM)



creta (opz.95F8I), vetro bronzo (opz.BZ)  
clay (opt.95F8I), bronze glass (opt.BZ)

# Liscia laccata opaca

SP. 24 MM

Neck  
Bridge

## CARATTERISTICHE TECNICHE

### ANTE E FRONTALI CASSETTI

anta sp.24 mm in mdf certificato (conforme [US EPA TSCA Title VI](#)) laccata opaca soft **\*“LOW VOC”** nei colori :

[CLICCA QUI PER LA GAMMA COLORI DISPONIBILI](#)

### GOLE

[vedi pag.34-35](#)

### MANIGLIE

[vedi pag.40-41-42](#)

### STRUTTURE

di serie : nobilitato bianco (opz.001) schiena e ripiano bianco (opz.001)

a richiesta : nobilitato fango (opz.8860) schiena e ripiano fango (opz.8860)  
nobilitato conchiglia (opz.8910) schiena e ripiano conchiglia (opz.8910)  
nobilitato visone (opz.948M) schiena e ripiano visone (opz.948M)  
nobilitato lavagna (opz.9620) schiena e ripiano lavagna (opz.9620)  
nobilitato argilla (opz.9690) schiena e ripiano argilla (opz.9690)  
nobilitato lino effetto tela (opz.8920) schiena e ripiano conchiglia (opz.8910)



### MENSOLE

[vedi pag.44](#)

### ZOCCOLI

[vedi pag.43](#)



\* LE ANTE LACCATE SONO CONTRADDISTINTE DALL'UTILIZZO DI VERNICI CHE RISPONDONO AD ELEVATI STANDARD DI SICUREZZA.  
IN PARTICOLARE SONO CONFORMI AL REGOLAMENTO [REACH](#), NON CONTENGONO PERTANTO PRODOTTI CHIMICAMENTE CONSIDERATI PERICOLOSI COME LE SOSTANZE [CMR](#) E [SVHC](#) (cancerogene, mutagene, tossiche). SONO CONFORMI AGLI STANDARD INTERNAZIONALI DI EMISSIONE INDOOR [COV](#) (composti organici volatili) ATTRAVERSO LA CERTIFICAZIONE [GREENGUARD](#).  
TALE CERTIFICAZIONE INCLUDE CRITERI BASATI SULL'IMPATTO DELLE SOSTANZE CHIMICHE, SULLA SALUTE UMANA E RICHIEDE CHE I LIMITI DI EMISSIONE DEI [COV](#) TOTALI, SIANO TALI DA GARANTIRNE L'UTILIZZO ANCHE IN AMBIENTI CHE RICHIEDONO PARTICOLARI ESIGENZE COME SCUOLE E STRUTTURE SANITARIE.



# Liscia laccata lucida

SP. 24 MM

Neck  
Bridge

## CARATTERISTICHE TECNICHE

ANTE E FRONTALI  
CASSETTI

anta sp.24 mm in mdf certificato (conforme [US EPA TSCA Title VI](#)) laccata lucida spazzolata \***"LOW VOC"** nei colori : bianco assoluto (opz.741), cenere (opz.9548), argilla (opz.9504), grigio bromo (opz.9534), nero seppia (opz.7898), nebbia (opz.95F6)

[CLICCA QUI PER LA GAMMA COLORI DISPONIBILI](#)

GOLE

[vedi pag.34-35](#)

MANIGLIE

[vedi pag.40-41-42](#)

STRUTTURE

di serie : nobilitato bianco (opz.001) schiena e ripiano bianco (opz.001)

a richiesta : nobilitato fango (opz.8860) schiena e ripiano fango (opz.8860)  
nobilitato conchiglia (opz.8910) schiena e ripiano conchiglia (opz.8910)  
nobilitato visone (opz.948M) schiena e ripiano visone (opz.948M)  
nobilitato lavagna (opz.9620) schiena e ripiano lavagna (opz.9620)  
nobilitato argilla (opz.9690) schiena e ripiano argilla (opz.9690)  
nobilitato lino effetto tela (opz.8920) schiena e ripiano conchiglia (opz.8910)



MENSOLE

[vedi pag.44](#)

ZOCCOLI

[vedi pag.43](#)



\* LE ANTE LACCATE SONO CONTRADDISTINTE DALL'UTILIZZO DI VERNICI CHE RISPONDONO AD ELEVATI STANDARD DI SICUREZZA. IN PARTICOLARE SONO CONFORMI AL REGOLAMENTO [REACH](#), NON CONTENGONO PERTANTO PRODOTTI CHIMICAMENTE CONSIDERATI PERICOLOSI COME LE SOSTANZE [CMR](#) E [SVHC](#) (cancerogene, mutagene, tossiche). SONO CONFORMI AGLI STANDARD INTERNAZIONALI DI EMISSIONE INDOOR [COV](#) (composti organici volatili) ATTRAVERSO LA CERTIFICAZIONE [GREENGUARD](#). TALE CERTIFICAZIONE INCLUDE CRITERI BASATI SULL'IMPATTO DELLE SOSTANZE CHIMICHE, SULLA SALUTE UMANA E RICHIEDE CHE I LIMITI DI EMISSIONE DEI [COV](#) TOTALI, SIANO TALI DA GARANTIRNE L'UTILIZZO ANCHE IN AMBIENTI CHE RICHIEDONO PARTICOLARI ESIGENZE COME SCUOLE E STRUTTURE SANITARIE.



# Matt lacquered smooth

TH. 24 MM

Neck  
Bridge

## TECHNICAL FEATURES

### DOORS AND DRAWER FRONTS

24 mm-thick certified MDF door (conforming to [US EPA TSCA Title VI](#)) soft matt lacquered **\*“LOW VOC”** available in the following colours:

[CLICK HERE FOR THE RANGE OF AVAILABLE COLORS](#)

### FINGER RAILS

[see page 34-35](#)

### HANDLES

[see page 40-41-42](#)

### CARCASSES

**standard:** melamine-coated white (opt.001), white back and shelf (opt.001)

**on request:** melamine-coated mud (opt.8860), mud back and shelf (opt.8860)  
melamine-coated seashell (opt.8910), seashell back and shelf (opt.8910)  
melamine-coated mink (opt.948M), mink back and shelf (opt.948M)  
melamine-coated slate grey (opt.9620), slate grey back and shelf (opt.9620)  
melamine-coated clay (opt.9690), clay back and shelf (opt.9690)  
melamine-coated linen with canvas effect (opt.8920), seashell back and shelf (opt.8910)

### SHELVES

[see page 44](#)

### PLINTHS

[see page 43](#)

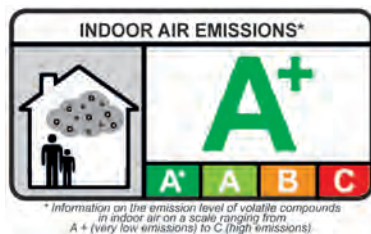

\* THE LACQUERED DOORS ARE DISTINGUISHED BY THE USE OF PAINTS CONFORMING TO STRINGENT SAFETY STANDARDS. IN PARTICULAR, THEY CONFORM TO [REACH](#) SPECIFICATIONS AND ARE THEREFORE FREE OF CHEMICAL PRODUCTS REGARDED AS HAZARDOUS, SUCH AS [CMR](#) (carcinogenic, mutagenic, reprotoxic) SUBSTANCES AND [SVHC](#). THEY CONFORM TO THE INTERNATIONAL STANDARDS FOR INDOOR [VOC](#) (volatile organic compounds) EMISSIONS THROUGH THE [GREENGUARD](#) CERTIFICATION. THIS CERTIFICATION INCLUDES CRITERIA BASED ON THE IMPACT OF CHEMICAL SUBSTANCES ON HUMAN HEALTH AND REQUIRES THAT THE LIMITS FOR TOTAL [VOC](#) EMISSIONS ARE ABLE TO GUARANTEE THEIR USE ALSO IN ENVIRONMENTS SUBJECT TO SPECIAL REQUIREMENTS, SUCH AS SCHOOLS AND HEALTHCARE FACILITIES.

# Glossy lacquered smooth

TH. 24 MM

Neck  
Bridge

## TECHNICAL FEATURES

### DOORS AND DRAWER FRONTS

24 mm-thick certified MDF door (conforming to [US EPA TSCA Title VI](#)) brushed glossy lacquered \***“LOW VOC”** available in the following colours:

[CLICK HERE FOR THE RANGE OF AVAILABLE COLORS](#)

### FINGER RAILS

[see page 34-35](#)

### HANDLES

[see page 40-41-42](#)

### CARCASSES

**standard:** melamine-coated white (opt.001), white back and shelf (opt.001)

**on request:** melamine-coated mud (opt.8860), mud back and shelf (opt.8860)  
melamine-coated seashell (opt.8910), seashell back and shelf (opt.8910)  
melamine-coated mink (opt.948M), mink back and shelf (opt.948M)  
melamine-coated slate grey (opt.9620), slate grey back and shelf (opt.9620)  
melamine-coated clay (opt.9690), clay back and shelf (opt.9690)  
melamine-coated linen with canvas effect (opt.8920), seashell back and shelf (opt.8910)

### SHELVES

[see page 44](#)

### PLINTHS

[see page 43](#)

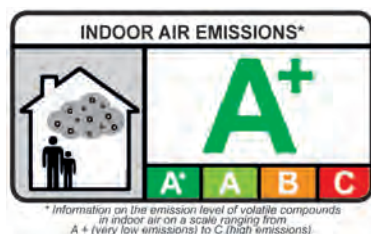

\* THE LACQUERED DOORS ARE DISTINGUISHED BY THE USE OF PAINTS CONFORMING TO STRINGENT SAFETY STANDARDS. IN PARTICULAR, THEY CONFORM TO [REACH](#) SPECIFICATIONS AND ARE THEREFORE FREE OF CHEMICAL PRODUCTS REGARDED AS HAZARDOUS, SUCH AS [CMR](#) (carcinogenic, mutagenic, reprotoxic) SUBSTANCES AND [SVHC](#). THEY CONFORM TO THE INTERNATIONAL STANDARDS FOR INDOOR [VOC](#) (volatile organic compounds) EMISSIONS THROUGH THE [GREENGUARD](#) CERTIFICATION. THIS CERTIFICATION INCLUDES CRITERIA BASED ON THE IMPACT OF CHEMICAL SUBSTANCES ON HUMAN HEALTH AND REQUIRES THAT THE LIMITS FOR TOTAL [VOC](#) EMISSIONS ARE ABLE TO GUARANTEE THEIR USE ALSO IN ENVIRONMENTS SUBJECT TO SPECIAL REQUIREMENTS, SUCH AS SCHOOLS AND HEALTHCARE FACILITIES.

**SP. 24 MM** TH. 24 MM

---

ante laccate opache matt doors lacquered



**SP. 24 MM** TH. 24 MM

---

ante laccate lucide glossy doors lacquered



**N**eck

**B**ridge

[CLICCA QUI PER LA GAMMA COLORI DISPONIBILI](#)

[CLICK HERE FOR THE RANGE OF AVAILABLE COLORS](#)



# Laccata liscia vintage

Vintage smooth lacquered

SP. 24 MM TH. 24 MM

Neck

Bridge

## CARATTERISTICHE TECNICHE

**ANTE E FRONTALI CASSETTI** anta sp.24 mm in mdf laccata **finitura semilucida effetto metallo vintage spazzolato** nei colori: bronzo antico (opz.8909), rame antico (opz.8159), nichel (opz.9505), bronzo brunito (opz.8903), grafite (opz.9508), urban (opz.7894)

**GOLE** vedi pag.34-35

**MANIGLIE** vedi pag.40-41-42

**STRUTTURE**  
**ANTE: bronzo, rame antico, bronzo brunito, bronzo antico**  
di serie: nobilitato fango (opz.8860) schiena e ripiano fango (opz.8860)  
  
**ANTA: nichel**  
di serie: nobilitato visone (opz.948M) schiena e ripiano visone (opz.948M)  
  
**ANTE: grafite, urban**  
di serie : nobilitato lavagna (opz.9620) schiena e ripiano lavagna (opz.9620)  
  
a richiesta : nobilitato bianco (opz.001) schiena e ripiano bianco (opz.001)  
nobilitato conchiglia (opz.8910) schiena e ripiano conchiglia (opz.8910)  
nobilitato argilla (opz.9690) schiena e ripiano argilla (opz.9690)  
nobilitato lino effetto tela (opz.8920) schiena e ripiano conchiglia (opz.8910)



**MENSOLE** vedi pag.44

**ZOCCOLI** vedi pag.43

## TECHNICAL FEATURES

**DOORS AND DRAWER FRONTS** 24 mm-thick lacquered MDF door with **semi-glossy finish with brushed vintage metal effect** in the following colours: antiqued bronze (opt.8909), antiqued copper (opt.8159), nickel (opt.9505), burnished bronze (opt.8903), graphite (opt.9508), urban (opt.7894)

**FINGER RAILS** see page 34-35

**HANDLES** see page 40-41-42

**CARCASSES**  
**DOORS: bronze, antiqued copper, burnished bronze, antiqued bronze**  
standard: melamine-coated mud (opt.8860) mud back and shelf (opt.8860)  
**DOOR: nickel**  
standard: melamine-coated mink (opt.948M), mink back and shelf (opt.948M)  
  
**DOORS: grafite, urban**  
standard: melamine-coated slate grey (opt.9620) slate grey back and shelf (opt.9620)  
  
on request: melamine-coated white (opt.001), white back and shelf (opt.001)  
melamine-coated seashell (opt.8910), seashell back and shelf (opt.8910)  
melamine-coated clay (opt.9690), clay back and shelf (opt.9690)  
melamine-coated linen with canvas effect (opt.8920), seashell back and shelf (opt.8910)

**SHELVES** see page 44

**PLINTHS** see page 43

SP. 24 MM TH. 24 MM

---

Neck

Bridge

ante laccate vintage effetto spazzolato  
lacquered vintage doors brushed effect



bronzo antico (opz.8909)  
antiqued bronze



rame antico (opz.8159)  
antiqued copper



nicel (opz.9505)  
nickel



bronzo brunito (opz.8903)  
burnished bronze



grafite (opz.9508)  
graphite



urban (opz.7894)  
urban

### Telaio alluminio

Aluminium frame

telaio alluminio verniciato rame sp.24 mm vetro extrachiaro, fumè o bronzo

24 mm-thick copper-coated aluminium frame with extra-clear, tinted or bronze glass



telaio rame con vetro extrachiaro  
(opz.FLRE)  
copper frame with extra-clear glass  
(opt.FLRE)



telaio rame con vetro fumè  
(opz.FLRF)  
copper frame with tinted glass  
(opt.FLRF)



telaio rame con vetro bronzo  
(opz.FLRB)  
copper frame with bronze glass  
(opt.FLRB)



particolare presa maniglia  
ricavata all'interno dei quattro  
lati dell'anta  
detail of the handle grip  
designed inside the four sides  
of the door

telaio alluminio verniciato ottone sp.24 mm vetro extrachiaro, fumè o bronzo

24 mm-thick brass-coated aluminium frame with extra-clear, tinted or bronze glass



telaio ottone con vetro extrachiaro  
(opz.FLTE)  
brass frame with extra-clear glass  
(opt.FLTE)



telaio ottone con vetro fumè  
(opz.FLTF)  
brass frame with tinted glass  
(opt.FLTF)



telaio ottone con vetro bronzo  
(opz.FLTB)  
brass frame with bronze glass  
(opt.FLTB)



particolare presa maniglia  
ricavata all'interno dei  
quattro lati dell'anta  
detail of the handle grip  
designed inside the four  
sides of the door

# Vetro

## Glass

Neck  
Bridge

### Telaio alluminio

Aluminium frame

telaio alluminio verniciato nero sp.24 mm vetro extrachiaro, fumè o bronzo

24 mm-thick black-coated aluminium frame with extra-clear, tinted or bronze glass



telaio nero con vetro extrachiaro  
(opz.FLNE)  
black frame with extra-clear glass  
(opt.FLNE)



telaio nero con vetro fumè  
(opz.FLNF)  
black frame with tinted glass  
(opt.FLNF)



telaio nero con vetro bronzo  
(opz.FLNB)  
black frame with bronze glass  
(opt.FLNB)



particolare presa maniglia  
ricavata all'interno dei  
quattro lati dell'anta  
detail of the handle grip  
designed inside the four  
sides of the door

# Finiture gole / Finger rails finishes

## Neck

---

**Finiture gole  
spazzolate**  
Finger rails  
brushed finishes



titanio ossidato  
(opz.414)  
titanium oxidized  
(opt.414)



urban ossidato (opz.NUL)  
urban oxidized (opt.NUL)



grafite ossidato (opz.421)  
graphite oxidized (opt.421)

N.B.: ABBINABILE CON L'ANTA  
LACCATA VINTAGE BRONZO BRUNITO  
NOTE: BEST MATCHING WITH THE  
BURNISHED LACQUERED VINTAGE  
BRONZE DOOR



bronzo anticato  
(opz.8909)  
antiqued bronze  
(opt.8909)



rame anticato (opz.422)  
antiqued copper (opt.422)

# Finiture gole / Finger rails finishes

**Finiture gole  
verniciate a polvere  
opache**  
Matt finger rails  
powder coated finishes

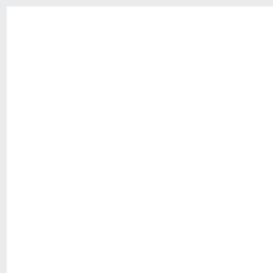

**bianco assoluto** (opz.740S)  
**absolute white** (opt.740S)

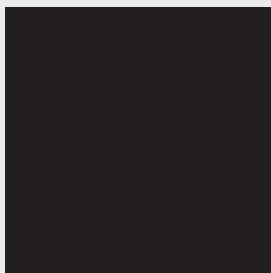

**nero** (opz.7892)  
**black** (opt.7892)  
N.B.: ABBINABILE CON L'ANTA  
LACCATA NERO SEPIA  
NOTE: BEST MATCHING WITH THE  
LACQUERED CUTTLEFISH INK DOOR

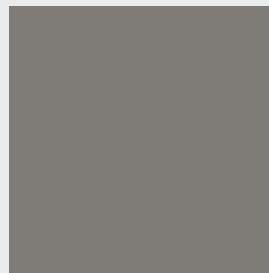

**fumo** (opz.9531)  
**smoke** (opt.9531)

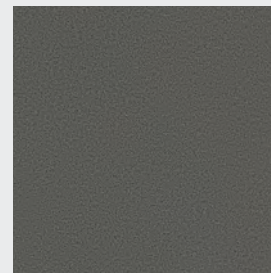

**silver dark** (opz.9507)  
**dark silver** (opt.9507)  
N.B.: ABBINABILE CON L'ANTA  
LACCATA GRIGIO QUARZO  
NOTE: BEST MATCHING WITH THE  
LACQUERED QUARTZ GREY DOOR

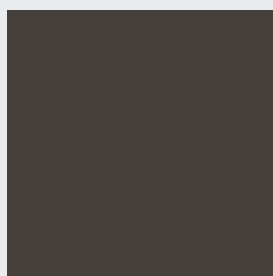

**ghisa** (opz.9509)  
**cast iron** (opt.9509)

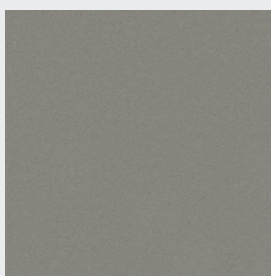

**grigio selce** (opz.SEL)  
**flint grey** (opt.SEL)

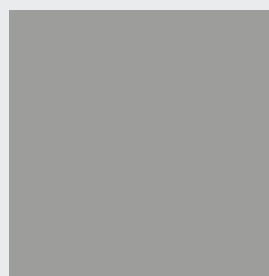

**grigio traffico** (opz.9511)  
**traffic grey** (opt.9511)  
N.B.: ABBINABILE CON L'ANTA  
LACCATA NEBBIA  
NOTE: BEST MATCHING WITH THE  
LACQUERED FOG DOOR

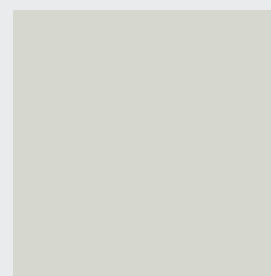

**cenere** (opz.9547)  
**ash** (opt.9547)

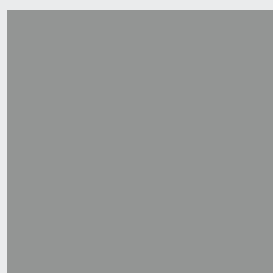

**argilla** (opz.9503)  
**clay** (opt.9503)

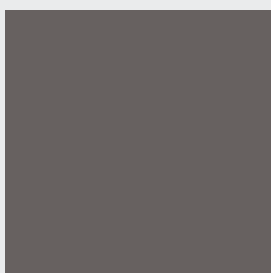

**grigio piombo** (opz.9537)  
**lead grey** (opt.9537)

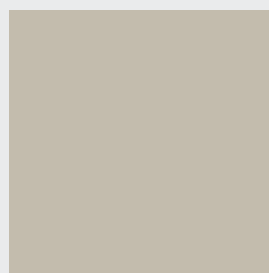

**polvere** (opz.9539)  
**dust** (opt.9539)

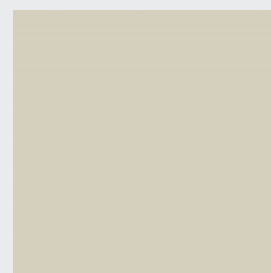

**conchiglia** (opz.7403)  
**seashell** (opt.7403)

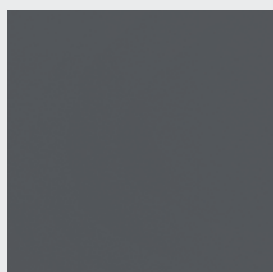

**carbon** (opz.W920)  
**carbon** (opt.W920)  
N.B.: ABBINABILE CON L'ANTA  
LACCATA GRIGIO LAVA  
NOTE: BEST MATCHING WITH THE  
LACQUERED LAVA GREY DOOR

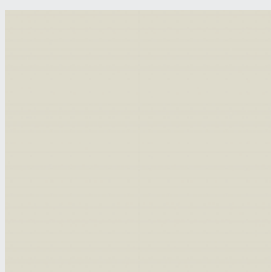

**lino** (opz.W770)  
**linen** (opt.W770)

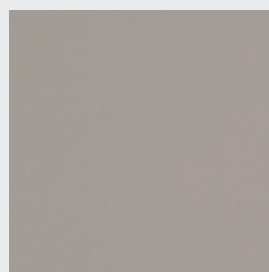

**mandorla** (opz.W820)  
**almond** (opt.W820)  
N.B.: ABBINABILE CON L'ANTA  
LACCATA GRIGIO REALE  
NOTE: BEST MATCHING WITH THE  
LACQUERED REAL GREY DOOR

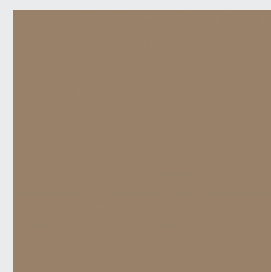

**ottone** (opz.7761)  
**brass** (opt.7761)  
N.B.: ABBINABILE  
CON L'ANTA VETRO TELAIO OTTONE  
NOTE: BEST MATCHING WITH THE  
GLASS DOOR WITH BRASS FRAME

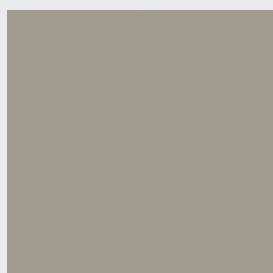



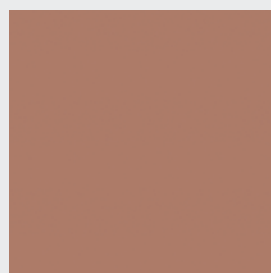



**creta** (opz.9515)  
**clay** (opt.9515)



**rame** (opz.8167)  
**copper** (opt.8167)

# GOLA "ELLE" ORIZZONTALE SOTTOTOP

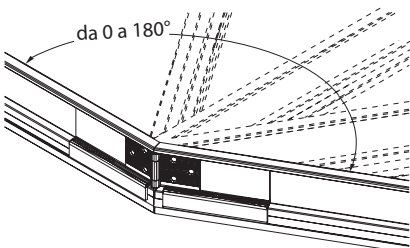
UNDERMOUNT HORIZONTAL "ELLE" FINGER RAIL



	COD.			COD.		
<p><b>Gola sottotop tipo "A"</b> Type "A" undermount finger rail</p>  <p style="text-align: right;"><b>al ml</b> per lm</p>	G950010			<p><b>Angolo interno a 90° per gola tipo "A"</b> 90° interior corner for "A" type finger rail</p>  <p style="text-align: right;"><b>cadauno</b> each</p>	G950050	
<p><b>Terminale aperto dx o sx per gola tipo "A" da utilizzare a fine composizione</b> RH or LH open end for type "A" finger rail to be placed at the end of the composition</p>  <p style="text-align: right;"><b>terminale DX</b> RH end <b>terminale SX</b> LH end</p>	G950021			<p><b>Angolare con snodo per unione fuori squadra per gola tipo "A"</b> Corner piece with joint for out-of-plumb joining for type "A" finger rail</p>  		
<p><b>Terminale chiuso dx o sx per gola tipo "A" da utilizzare solo tra basi e colonne</b> RH or LH closure for type "A" finger rail to be placed only between base units and column</p>  <p style="text-align: right;"><b>terminale DX</b> RH end <b>terminale SX</b> LH end</p>	G950031					
<p><b>Terminale chiuso dx o sx per gola tipo "A" da utilizzare solo tra basi e colonne</b> RH or LH closure for type "A" finger rail to be placed only between base units and column</p> <p style="text-align: right;"><b>terminale DX</b> RH end <b>terminale SX</b> LH end</p>	G950032					G950060
<p><b>Coppia angolari per kit raccordo base angolo 110x110</b> Couple corner piece for fitting kit corner base unit 110x110</p>  <p style="text-align: center;">SX LH                      DX RH</p> <p style="text-align: right;"><b>in alluminio</b> aluminium <b>angolare DX</b> RH corner piece <b>angolare SX</b> LH corner piece</p>	G950058					
	G950059					





# GOLA "ELLE" ORIZZONTALE INTERMEDIA

INTERMEDIATE HORIZONTAL "ELLE" FINGER RAIL

# GOLE "ELLE" VERTICALI PER COLONNE

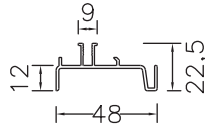
VERTICAL "ELLE" FINGER RAILS FOR COLUMNS

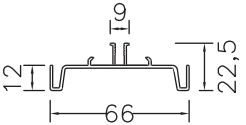
	COD.	
<p><b>Gola intermedia tipo "B"</b></p> <p>Type "B" intermediate finger rail</p>  <p style="text-align: right;"><b>al ml</b> per lm</p>	G950110	
<p><b>Terminale aperto dx o sx per gola tipo "B" da utilizzare a fine composizione</b></p> <p>RH or LH open end for type "B" finger rail to be placed at the end of the composition</p>  <p style="text-align: right;"><b>terminale DX</b> RH end</p> <p style="text-align: right;"><b>terminale SX</b> LH end</p>	G950121 G950122	
<p><b>Terminale chiuso dx o sx per gola tipo "B" da utilizzare solo tra cassettiere e lavastoviglie/colonne</b></p> <p>RH or LH closure for type "B" finger rail to be placed only between drawer units and dishwasher/columns</p>  <p style="text-align: right;"><b>terminale DX</b> RH end</p> <p style="text-align: right;"><b>terminale SX</b> LH end</p>	G950131 G950132	

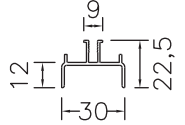
	COD.	
<p><b>Mezza gola verticale tipo "C" (completa di distanziale)</b></p> <p>Type "C" half vertical finger rail (complete with spacer)</p>   <p style="text-align: center;"><b>sezione mezza gola tipo "C"</b> cross section of type "C" finger rail</p> <p><b>Piedi H 13</b> H 96 H 132 H 204 H 228</p> <p><b>Piedi H 6</b> H 108 H 144 H 216</p>	G950310 G950330 G950350 G950370 G950320 G950340 G950360	
<p><b>Gola verticale intermedia tipo "D" (completa di distanziale)</b></p> <p>Type "D" intermediate vertical finger rail (complete with spacer)</p>   <p style="text-align: center;"><b>sezione gola tipo "D"</b> cross section of type "D" finger rail</p> <p><b>Piedi H 13</b> H 96 H 132 H 204 H 228</p> <p><b>Piedi H 6</b> H 108 H 144 H 216</p>	G950410 G950430 G950450 G950470 G950420 G950440 G950460	
<p><b>Gola verticale laterale tipo "E" (completa di distanziale)</b></p> <p>Type "E" lateral vertical finger rail (complete with spacer)</p>   <p style="text-align: center;"><b>sezione gola tipo "E"</b> cross section of type "E" finger rail</p> <p><b>Piedi H 13</b> H 96 H 132 H 204 H 228</p> <p><b>Piedi H 6</b> H 108 H 144 H 216</p>	G950510 G950530 G950550 G950570 G950520 G950540 G950560	



# NOZIONI UTILI - gole "elle" orizzontali per basi

USEFUL INFORMATION - HORIZONTAL "ELLE" FINGER RAILS FOR BASE UNITS

## VISTA FRONTALE ZOCCOLO H 13 PER BASI H 88

FRONT VIEW PLINTH H 13 FOR BASE UNITS H 88

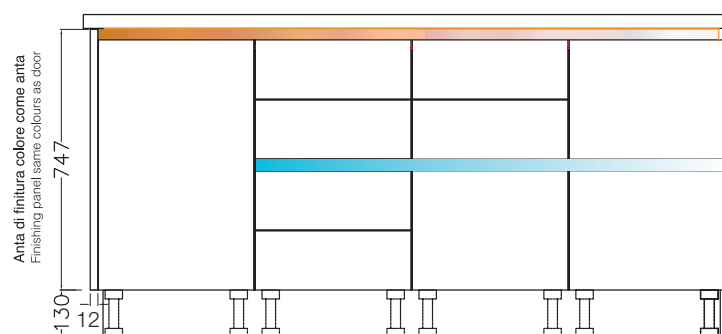
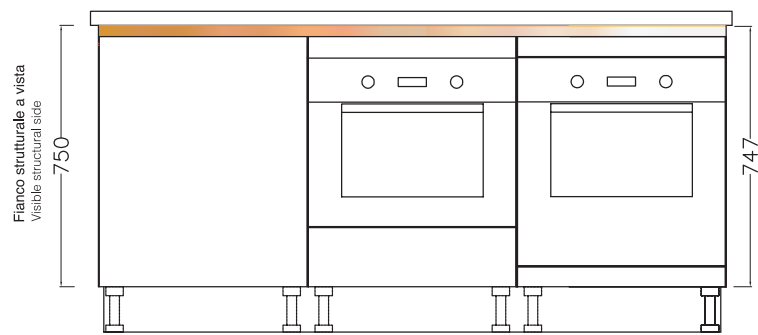

## VISTA FRONTALE ZOCCOLO H 6 PER BASI H 90

FRONT VIEW PLINTH H 6 FOR BASE UNITS H 90

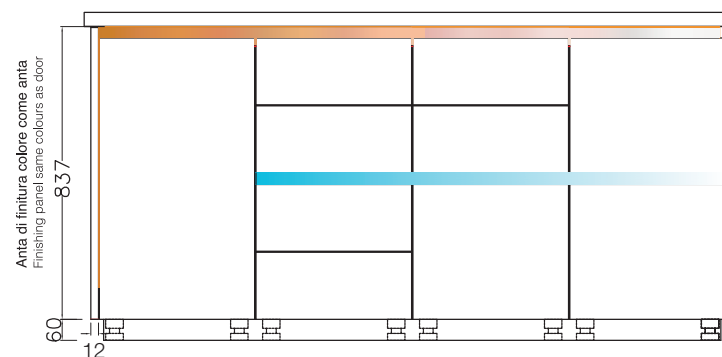
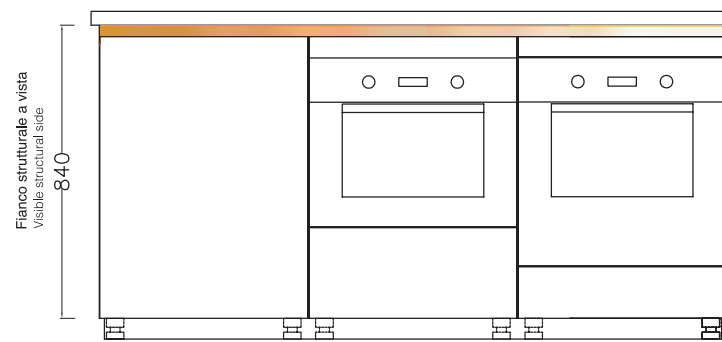

## VISTA LATERALE (sezione) ZOCCOLO H 13 PER BASI H 88

SIDE VIEW (CROSS SECTION) PLINTH H 13 FOR BASE UNITS H 88

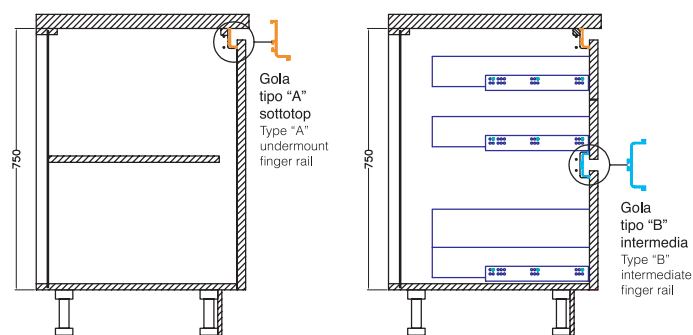

## VISTA LATERALE (sezione) ZOCCOLO H 6 PER BASI H 90

SIDE VIEW (CROSS SECTION) PLINTH H 6 FOR BASE UNITS H 90

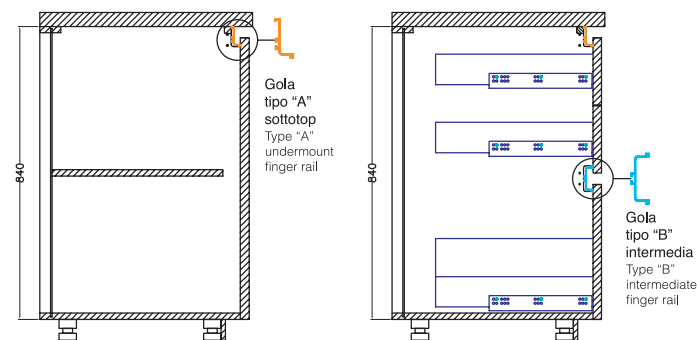

## VISTA DALL'ALTO

TOP VIEW

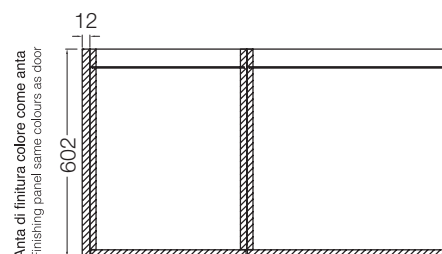
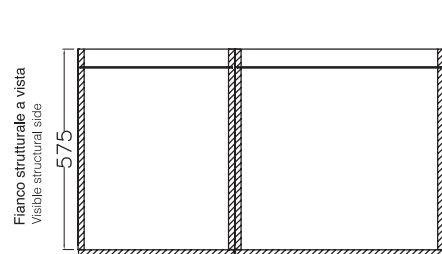

Composizione con ante di finitura laterali: alla dimensione finale della cucina, sommare sempre lo spessore delle ante di finitura (ogni anta 1,2 cm)

Composition with side finishing panels: to the final size of the kitchen, always add the thickness of the finishing panels (each panel 12 mm)

# NOZIONI UTILI - gole "elle" verticali per colonne

USEFUL INFORMATION - VERTICAL "ELLE" FINGER RAILS FOR COLUMNS

## VISTA FRONTALE ZOCCOLO H 13

FRONT VIEW PLINTH H 13

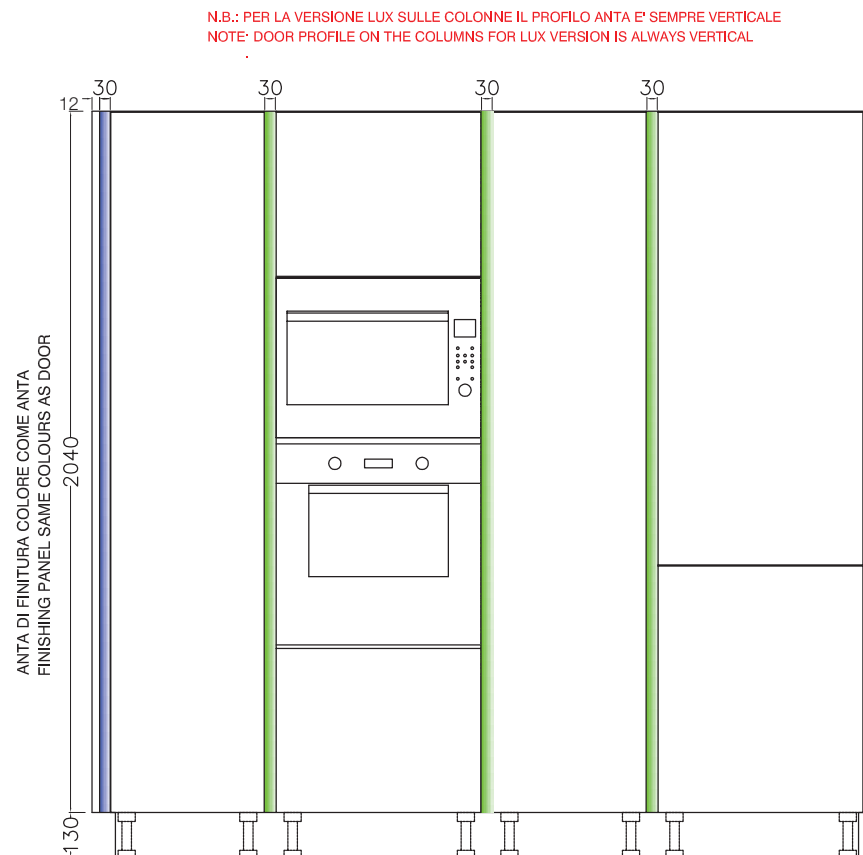

## VISTA FRONTALE ZOCCOLO H 6

FRONT VIEW PLINTH H 6

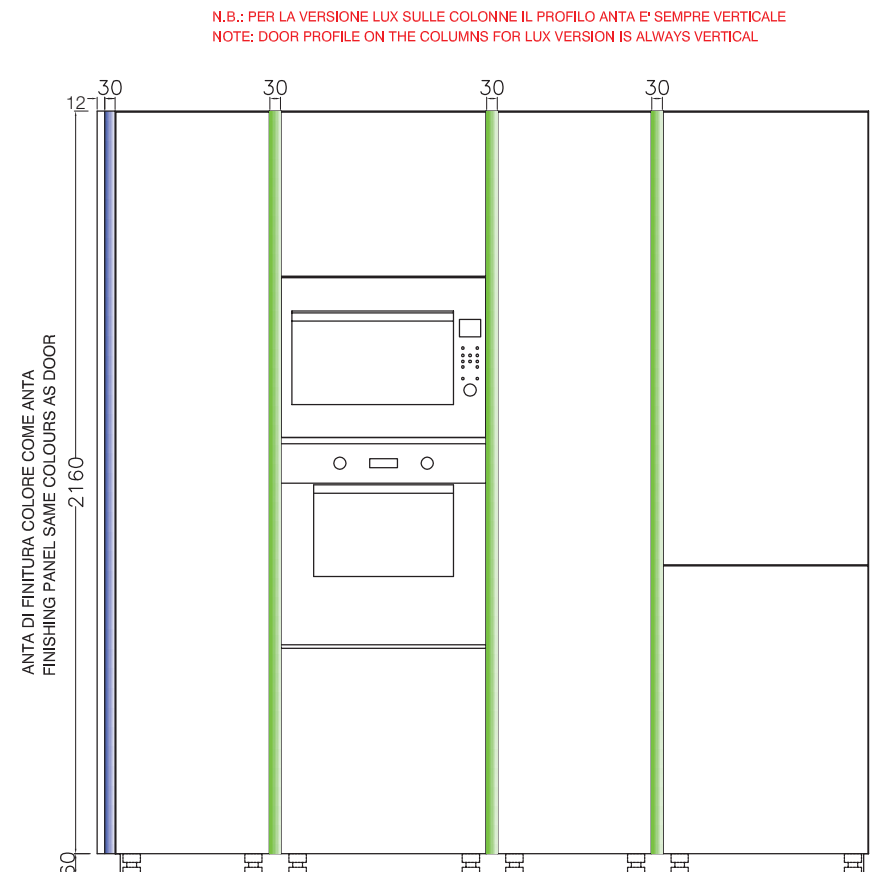

## VISTA DALL'ALTO

TOP VIEW

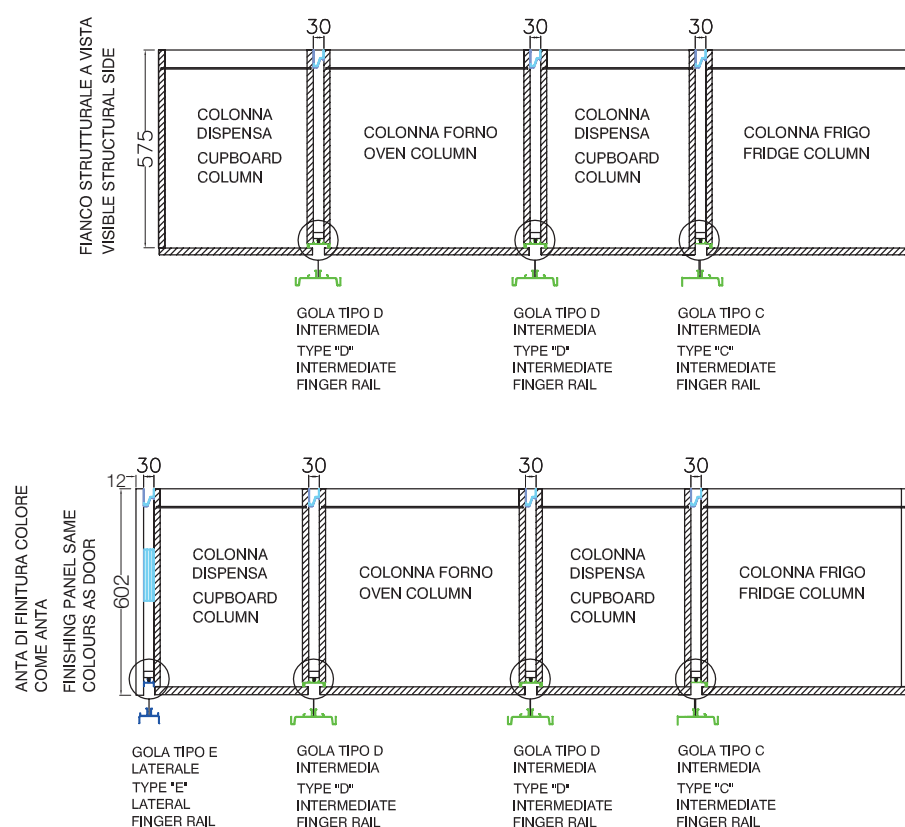

Composizione fianco strutturale  
a vista come anta:  
alla dimensione finale della cucina,  
sommare sempre lo spessore dei  
distanziali tra le colonne  
(ogni distanziale 3 cm)

Composition with visible side panel to match door:  
to the final size of the kitchen, always add the thickness  
of the spacers between the two columns (each spacer 3 cm)

Composizione con ante di finitura  
laterali, alla dimensione finale della  
cucina, sommare sempre lo spessore  
dei distanziali tra le colonne  
(ogni distanziale 3 cm) e lo spessore  
delle ante di finitura (ogni anta 1,2 cm)

Composition with side finishing panels to the final size of the  
kitchen, always add the thickness of the spacer between the  
two columns (each spacer 3 cm) and the thickness of the  
finishing panels (each panel 12 mm)

## DI SERIE STANDARD



Maniglia 556T finitura grigio titanio  
 anta L 15 → pomo  
 anta L 30 a L 45 → passo 160 mm  
 anta da L 60 a L 120 → passo 320 mm

Handle 556T titanium grey finish  
 door W 15 → knob  
 door W 30 to W 45 → centre-to-centre distance 160 mm  
 door from W 60 to W 120 → centre-to-centre distance 320 mm



Pomo finitura grigio titanio  
 utilizzato per elementi da 15  
 con maniglia 556T

Knob titanium grey finish  
 used for 15 cm elements with handle 556T



Maniglia 556C finitura creta  
 anta L 15 → pomo  
 anta L 30 a L 45 → passo 160 mm  
 anta da L 60 a L 120 → passo 320 mm

Handle 556C clay finish  
 door W 15 → knob  
 door W 30 to W 45 → centre-to-centre distance 160 mm  
 door from W 60 to W 120 → centre-to-centre distance 320 mm



Pomo finitura creta  
 utilizzato per elementi da 15  
 con maniglia 556C

Knob clay finish  
 used for 15 cm elements with handle 556C

## A RICHIESTA ON REQUEST



Maniglia 59S finitura anodizzato silver dark  
 anta L 15 → passo 32 mm  
 anta L 30 a L 45 → passo 160 mm  
 anta da L 60 a L 120 → passo 448 mm

Handle 59S oxidized dark silver finish  
 door W 15 → centre-to-centre distance 32 mm  
 door W 30 to W 45 → centre-to-centre distance 160 mm  
 door from W 60 to W 120 → centre-to-centre distance 448 mm



Maniglia 59RA finitura anodizzato rame anticato  
 anta L 15 → passo 32 mm  
 anta L 30 a L 45 → passo 160 mm  
 anta da L 60 a L 120 → passo 448 mm

Handle 59RA oxidized antiqued copper finish  
 door W 15 → centre-to-centre distance 32 mm  
 door W 30 to W 45 → centre-to-centre distance 160 mm  
 door from W 60 to W 120 → centre-to-centre distance 448 mm



Maniglia 59BA finitura anodizzato bronzo anticato  
 anta L 15 → passo 32 mm  
 anta L 30 a L 45 → passo 160 mm  
 anta da L 60 a L 120 → passo 448 mm

Handle 59BA oxidized antiqued bronze finish  
 door W 15 → centre-to-centre distance 32 mm  
 door W 30 to W 45 → centre-to-centre distance 160 mm  
 door from W 60 to W 120 → centre-to-centre distance 448 mm



Maniglia 59BB finitura anodizzato titanio  
 anta L 15 → passo 32 mm  
 anta L 30 a L 45 → passo 160 mm  
 anta da L 60 a L 120 → passo 448 mm

Handle 59BB oxidized titanium finish  
 door W 15 → centre-to-centre distance 32 mm  
 door W 30 to W 45 → centre-to-centre distance 160 mm  
 door from W 60 to W 120 → centre-to-centre distance 448 mm



Maniglia 59N finitura anodizzato nero  
 anta L 15 → passo 32 mm  
 anta L 30 a L 45 → passo 160 mm  
 anta da L 60 a L 120 → passo 448 mm

Handle 59N oxidized black finish  
 door W 15 → centre-to-centre distance 32 mm  
 door W 30 to W 45 → centre-to-centre distance 160 mm  
 door from W 60 to W 120 → centre-to-centre distance 448 mm



Maniglia 59G finitura ghisa  
 anta L 15 → passo 32 mm  
 anta L 30 a L 45 → passo 160 mm  
 anta da L 60 a L 120 → passo 448 mm

Handle 59G cast iron finish  
 door W 15 → centre-to-centre distance 32 mm  
 door W 30 to W 45 → centre-to-centre distance 160 mm  
 door from W 60 to W 120 → centre-to-centre distance 448 mm

## A RICHIESTA ON REQUEST



Maniglia 591S finitura silver dark  
 anta L 15 → passo 96 mm  
 anta L 30 a L 45 → passo 160 mm  
 anta da L 60 a L 120 → passo 320 mm

Handle 591S dark silver finish  
 door W 15 → centre-to-centre distance 96 mm  
 door W 30 to W 45 → centre-to-centre distance 160 mm  
 door from W 60 to W 120 → centre-to-centre distance 320 mm



Maniglia 591G finitura grigio selce  
 anta L 15 → passo 96 mm  
 anta L 30 a L 45 → passo 160 mm  
 anta da L 60 a L 120 → passo 320 mm

Handle 591G flint grey finish  
 door W 15 → centre-to-centre distance 96 mm  
 door W 30 to W 45 → centre-to-centre distance 160 mm  
 door from W 60 to W 120 → centre-to-centre distance 320 mm



Maniglia 577N finitura nichel satinato  
 anta L 15 → passo 64 mm  
 anta da L 30 a L 45 → passo 160 mm  
 anta da L 60 a L 120 → passo 320 mm

Handle 577N satin nickel finish  
 door W 15 → centre-to-centre distance 64 mm  
 door from W 30 to W 45 → centre-to-centre distance 160 mm  
 door from W 60 to W 120 → centre-to-centre distance 320 mm



Maniglia 57RA finitura rame anticato  
 anta L 15 → passo 12 mm  
 anta L 30 a L 45 → passo 160 mm  
 anta da L 60 a L 120 → passo 320 mm

Handle 57RA antiqued copper finish  
 door W 15 → centre-to-centre distance 12 mm  
 door W 30 to W 45 → centre-to-centre distance 160 mm  
 door from W 60 to W 120 → centre-to-centre distance 320 mm



Maniglia 57BA finitura bronzo anticato  
 anta L 15 → passo 12 mm  
 anta L 30 a L 45 → passo 160 mm  
 anta da L 60 a L 120 → passo 320 mm  
**N.B.: abbinabile con l'anta vetro telaio ottone**

Handle 57BA antiqued bronze finish  
 door W 15 → centre-to-centre distance 12 mm  
 door W 30 to W 45 → centre-to-centre distance 160 mm  
 door from W 60 to W 120 → centre-to-centre distance 320 mm  
**Note: best matching with the Glass door with brass frame**



Maniglia 57BB finitura bronzo brunito  
 anta L 15 → passo 12 mm  
 anta L 30 a L 45 → passo 160 mm  
 anta da L 60 a L 120 → passo 320 mm

Handle 57BB burnished bronze finish  
 door W 15 → centre-to-centre distance 12 mm  
 door W 30 to W 45 → centre-to-centre distance 160 mm  
 door from W 60 to W 120 → centre-to-centre distance 320 mm



Maniglia 57F finitura grafite  
 anta L 15 → passo 12 mm  
 anta L 30 a L 45 → passo 160 mm  
 anta da L 60 a L 120 → passo 320 mm

Handle 57F graphite finish  
 door W 15 → centre-to-centre distance 12 mm  
 door W 30 to W 45 → centre-to-centre distance 160 mm  
 door from W 60 to W 120 → centre-to-centre distance 320 mm

## A RICHIESTA ON REQUEST

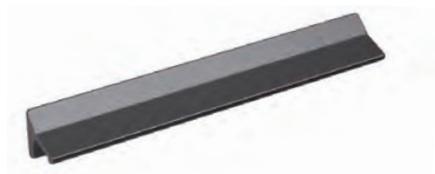

Maniglia 592S finitura silver dark  
 anta L 15 → passo 64 mm  
 anta L 30 a L 45 → passo 160 mm  
 anta da L 60 a L 120 → passo 320 mm

Handle 592S dark silver finish  
 door W 15 → centre-to-centre distance 64 mm  
 door W 30 to W 45 → centre-to-centre distance 160 mm  
 door from W 60 to W 120 → centre-to-centre distance 320 mm



Maniglia 592B finitura bronzo brunito  
 anta L 15 → passo 64 mm  
 anta L 30 a L 45 → passo 160 mm  
 anta da L 60 a L 120 → passo 320 mm

Handle 592B burnished bronze finish  
 door W 15 → centre-to-centre distance 64 mm  
 door W 30 to W 45 → centre-to-centre distance 160 mm  
 door from W 60 to W 120 → centre-to-centre distance 320 mm



Maniglia 557N finitura nichel  
 anta L 15 → pomo  
 anta L 30 a L 45 → passo 160 mm  
 anta da L 60 a L 120 → passo 320 mm

Handle 557N nickel finish  
 door W 15 → Knob  
 door W 30 to W 45 → centre-to-centre distance 160 mm  
 door from W 60 to W 120 → centre-to-centre distance 320 mm



Pomo finitura nichel  
 utilizzato per elementi da 15  
 con maniglia 557N

Knob nickel finish  
 used for 15 cm elements with handle 557N



Maniglia 557B finitura bronzo brunito  
 anta L 15 → pomo  
 anta L 30 a L 45 → passo 160 mm  
 anta da L 60 a L 120 → passo 320 mm

Handle 557B burnished bronze finish  
 door W 15 → Knob  
 door W 30 to W 45 → centre-to-centre distance 160 mm  
 door from W 60 to W 120 → centre-to-centre distance 320 mm



Pomo finitura bronzo brunito  
 utilizzato per elementi da 15  
 con maniglia 557B

Knob burnished bronze finish  
 used for 15 cm elements with handle 557B

## zoccoli in pvc H 13 pvc plinth H 13



acciaio (opz.407)  
steel (opt.407)



alluminio satinato (opz.405)  
satin aluminium (opt.405)

## zoccoli in alluminio H 13 aluminium plinth H 13



alluminio finitura  
grafite (opz.421)  
aluminium graphite  
finish (opt.421)



alluminio finitura urban  
ossidato (opz.NU)  
aluminium urban  
oxidized finish (opt.NU)



alluminio finitura titanio  
ossidato (opz.414)  
aluminium titanium  
oxidized finish (opt.414)



alluminio finitura rame  
antico (opz.422)  
aluminium antique  
copper finish (opt.422)



alluminio finitura  
brunzo antico (opz.423)  
aluminium antique  
bronze finish (opt.423)

N.B.: ABBINABILE CON L'ANTA  
LACCATA VINTAGE BRONZO BRUNITO  
NOTE: BEST MATCHING WITH THE  
BURNISHED LACQUERED VINTAGE  
BRONZE DOOR

## zoccoli in alluminio H 13 verniciati a polvere finitura opaca aluminium plinths H 13 powder coated matt finish



alluminio finitura  
grigio piombo  
(opz.9537)  
aluminium lead grey  
finish (opt.9537)



alluminio finitura nero  
(opz.7892)  
aluminium  
black finish (opt.7892)



alluminio finitura  
conchiglia (opz.7403)  
aluminium shell  
finish (opt.7403)



alluminio finitura  
silver dark (opz.9507)  
aluminium dark silver  
finish (opt.9507)

N.B.: ABBINABILE CON L'ANTA  
LACCATA NERO SEPIA  
NOTE: BEST MATCHING WITH THE  
LACQUERED CUTTLEFISH INK DOOR

N.B.: ABBINABILE CON L'ANTA  
LACCATA GRIGIO QUARZO  
NOTE: BEST MATCHING WITH THE  
LACQUERED QUARTZ GREY DOOR



alluminio finitura  
ghisa (opz.9509)  
aluminium cast iron  
finish (opt.9509)



alluminio carbon  
(opz.W920)  
aluminium carbon  
(opt.W920)



alluminio finitura  
polvere (opz.9539)  
aluminium dust  
finish (opt.9539)



alluminio grigio  
traffico (opz.9511)  
aluminium traffic grey  
finish (opt.9511)



alluminio finitura  
argilla (opz.9503)  
aluminium clay  
finish (opt.9503)



alluminio mandorla  
(opz.W820)  
aluminium  
almond (opt.W820)

N.B.: ABBINABILE CON L'ANTA  
LACCATA GRIGIO LAVA  
NOTE: BEST MATCHING WITH THE  
LACQUERED LAVA GREY DOOR

N.B.: ABBINABILE CON L'ANTA  
LACCATA NEBBIA  
NOTE: BEST MATCHING WITH THE  
LACQUERED FOG DOOR

N.B.: ABBINABILE CON L'ANTA  
LACCATA GRIGIO REALE  
NOTE: BEST MATCHING WITH THE  
LACQUERED REAL GREY DOOR



alluminio finitura  
creta (opz.9515)  
aluminium clay  
finish (opt.9515)



alluminio bistro  
(opz.9535)  
aluminium bistro  
finish (opt.9535)



alluminio lino  
(opz.W770)  
aluminium linen  
(opt.W770)



alluminio finitura  
grigio selce (opz.SE)  
aluminium flint grey  
finish (opt.SE)



alluminio finitura  
cenere (opz.9547)  
aluminium ash  
finish (opt.9547)



alluminio finitura fumo  
(opz.9531)  
aluminium smoke  
finish (opt.9531)



alluminio finitura  
bianco assoluto  
(opz.740S)  
aluminium absolute  
white finish (opt.740S)



alluminio finitura rame  
(opz.8167)  
aluminium copper  
finish (opt.8167)



alluminio finitura  
ottone (opz.7761)  
aluminium brass  
finish (opt.7761)

N.B.: ABBINABILE CON L'ANTA  
TELAIO VETRO TELAIU OTTONE  
NOTE: BEST MATCHING WITH THE  
GLASS DOOR WITH BRASS FRAME

## strutture carcasses



bianco (opz.001)  
schiena e ripiano bianco  
(opz.001)  
white (opt.001)  
white back panel and shelf  
(opt.001)



visone (opz.948M)  
schiena e ripiano visone  
(opz.948M)  
mink (opt.948M)  
mink back panel and shelf  
(opt.948M)



lavagna (opz.9620)  
schiena e ripiano lavagna  
(opz.9620)  
slate grey (opt.9620)  
slate grey back panel  
and shelf (opt.9620)



fango (opz.8860)  
schiena e ripiano fango  
(opz.8860)  
mud (opt.8860)  
mud back panel and shelf  
(opt.8860)



conchiglia (opz.8910)  
schiena e ripiano conchiglia  
(opz.8910)  
shell (opt.8910)  
shell back panel and shelf  
(opt.8910)



argilla (opz.9690)  
schiena e ripiano argilla  
(opz.9690)  
clay (opt.9690)  
clay back panel and shelf  
(opt.9690)



lino effetto tela (opz.8920)  
schiena e ripiano conchiglia  
(opz.8910)  
linen melamine-coated canvas  
effect (opt.8920)  
shell back panel and shelf (opt.8910)



### LUBE ECOLOGIC

IL GRUPPO LUBE HA SCELTO DI UTILIZZARE PER I COMPONENTI COSTITUENTI LE STRUTTURE DELLE CUCINE SOLO MATERIALE A BASSISSIMA EMISSIONE DI FORMALDEIDE: CONFORMI ALLO STANDARD F\*\*\*\* SECONDO LA NORMA JIS, CERTIFICATO DAL MINISTERO GIAPPONESE, IL PIU' SEVERO IN MERITO ALLE NORMATIVE DI SALVAGUARDIA AMBIENTALE.

LUBE GROUP HAS CHOSEN TO EXCLUSIVELY USE MATERIALS WITH VERY LOW FORMALDEHYDE EMISSIONS FOR THE COMPONENTS MAKING UP THE KITCHEN CARCASSES: THESE ELEMENTS COMPLY WITH THE F4 STAR STANDARD ACCORDING TO JIS, CERTIFIED BY THE JAPANESE GOVERNMENT - THE MOST STRINGENT WHEN IT COMES TO ENVIRONMENTAL PROTECTION.

## mensole in laminato P 31-61 come strutture same colours as carcasses laminate shelves D 31-61



bianco (opz.001)  
white (opt.001)

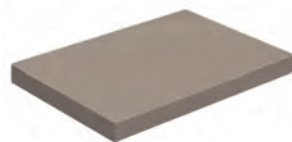

visone (opz.948M)  
mink (opt.948M)

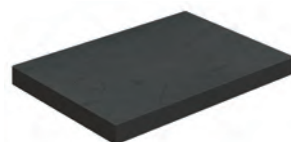

lavagna (opz.9620)  
slate grey (opt.9620)



conchiglia (opz.8910)  
shell (opt.8910)

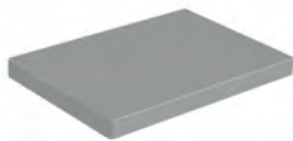

argilla (opz.9690)  
clay (opt.9690)

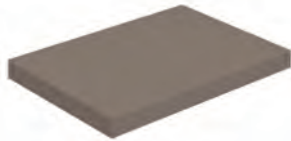

fango (opz.8860)  
mud (opt.8860)

## mensole impiallacciate veneered shelves



impiallacciata come anta  
N.B.: per le finiture vedi pagine 12-13  
veneered same finish as door  
Note: for the finishes see pages 12-13

## mensole laccate lacquered shelves

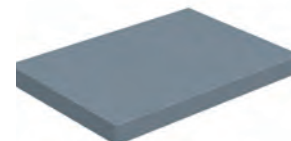

laccate opache e lucide come anta  
N.B.: per le finiture vedi pagine 28-29  
matt and glossy lacquered as door  
Note: for the finishes see pages 28-29

## mensole laccate vintage vintage lacquered shelves



laccate vintage come anta  
N.B.: per le finiture vedi pagina 31  
vintage lacquered as door  
Note: for the finishes see page 31

MODULARITÀ E COMPONENTITÀ MODULARITÀ AND FITTING SOLUTIONS

- ESCLUSO 65 SOLO 45/60
- ESCLUSO 45 SOLO 45/90
- ESCLUSO 45 SOLO 45/90
- ESCLUSO 120 SOLO 45
- ESCLUSO 120 SOLO 45

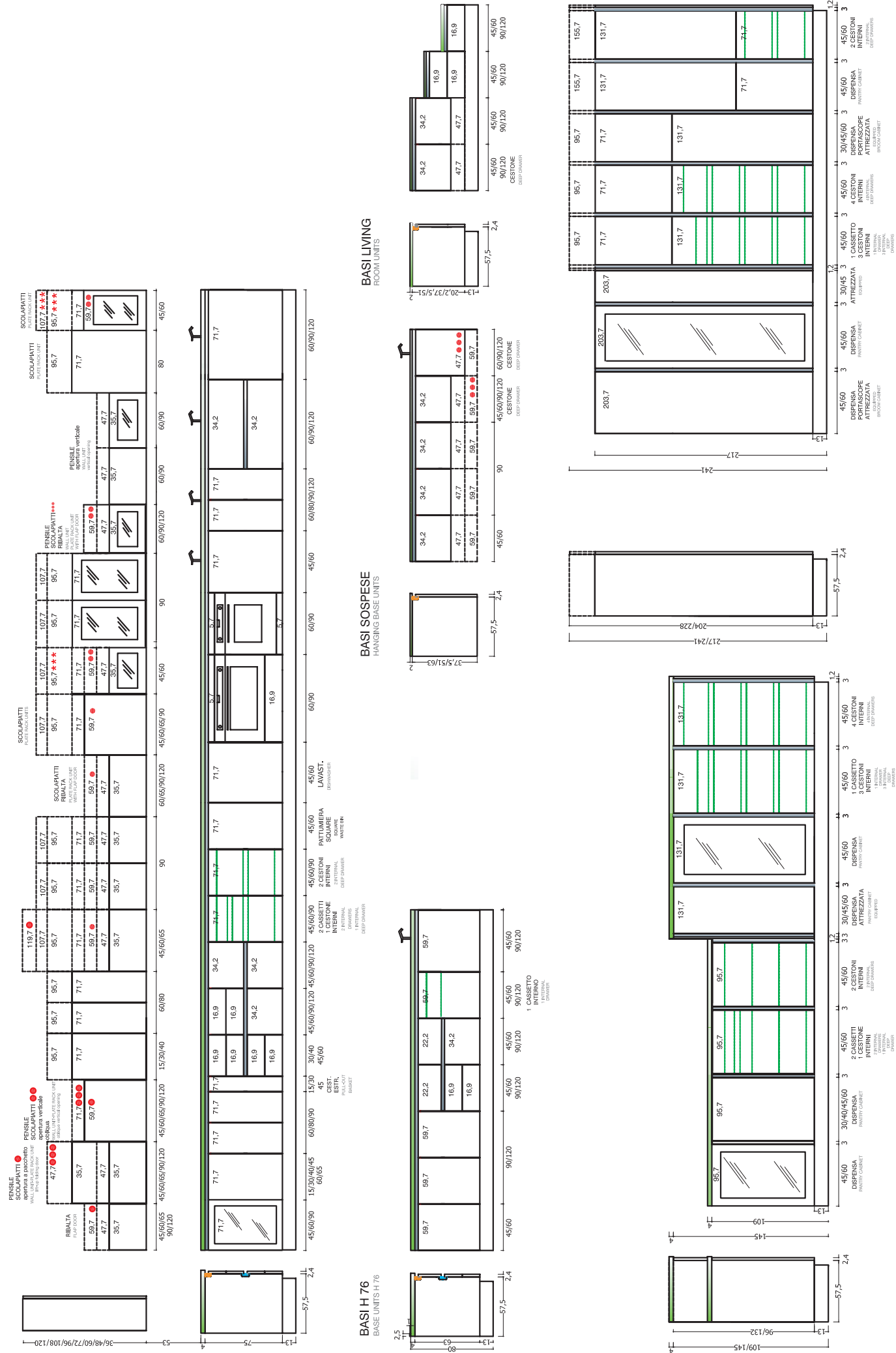





# MODULARITÀ E COMPONENTIBILITÀ MODULARITY AND FITTING SOLUTIONS

- ESCLUSO 85  
● ESCLUSO 85  
● ESCLUSO 85
- \* SOLO 45/60  
\* SOLO 45/60  
\* SOLO 45/60
- \*\* SOLO 45  
\*\* SOLO 45  
\*\* SOLO 45
- \*\*\* SOLO 45  
\*\*\* SOLO 45  
\*\*\* SOLO 45

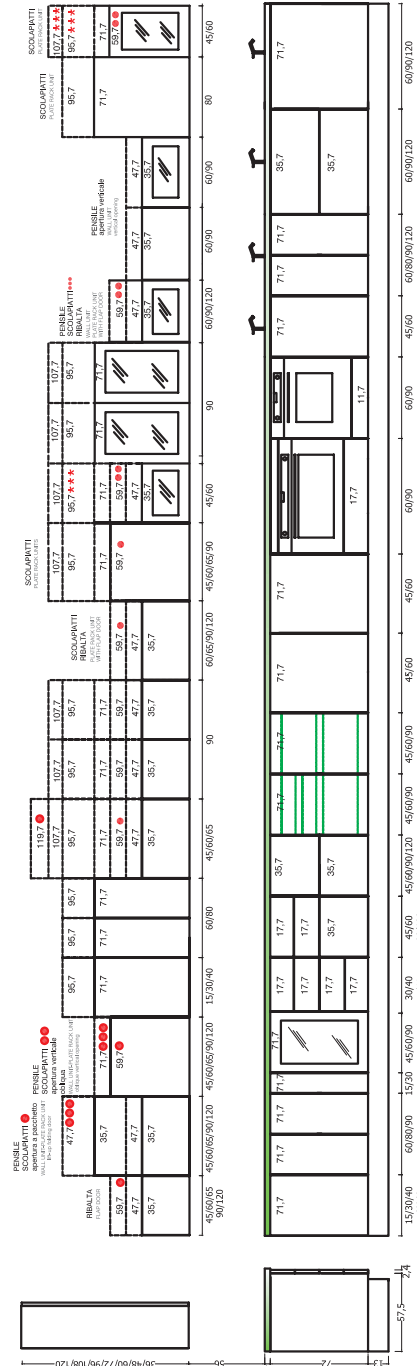

BASI H 73  
BASE UNITS H 73

BASI SOSPENSE  
HANGING BASE UNITS

BASI LIVING  
ROOM UNITS

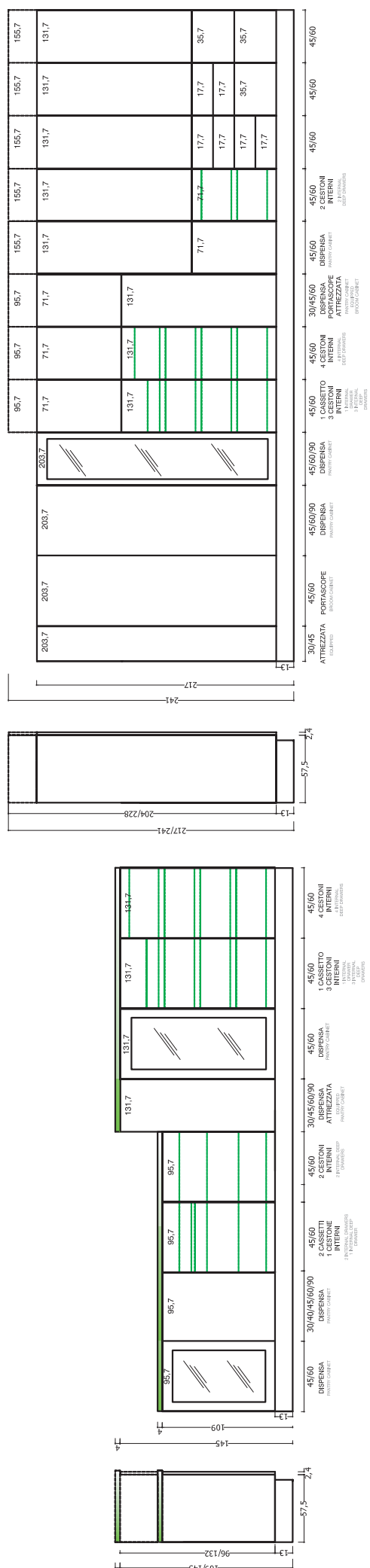



**APERTURA A RIBALTA**

Le ante aprendosi verso l'alto consentono di avere un' ampia visione d'insieme all'interno del mobile.

La regolazione della forza di apertura può essere impostata in modo esatto in base al peso del frontale. Grazie all'arresto progressivo le ante si fermano in qualsiasi posizione; in questo modo la maniglia è sempre facilmente raggiungibile. La chiusura è ammortizzata e un'unica manovra è sufficiente per regolare il frontale tridimensionalmente grazie all'assenza di cerniere e al sistema di aggancio clip.

WALL UNIT WITH FLAP DOOR

The doors that open upwards guarantee ample overall visibility inside the cabinet.

The opening force can be adjusted precisely according to the weight of the front. The doors stop in any position thanks to the gradual stopping movement; in this way, the handle is always easily accessible. The closing movement is cushioned and a single manoeuvre is required to three-dimensionally adjust the front, thanks to the clip-on system and the absence of hinges.



**DI SERIE**  
STANDARD



**MOTORIZZATO**  
**SERVO-DRIVE**  
SERVO-DRIVE  
MOTORISED  
(Opz.007)

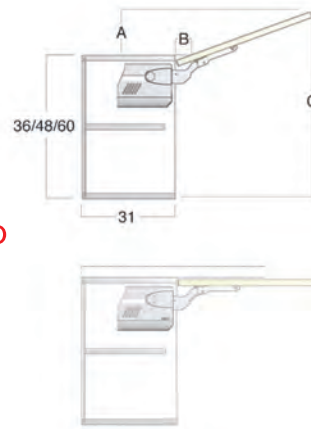

	A	B	C
H 36	11,5	3,5	37
H 48	15	3,5	49
H 60	18,5	3,5	61

Per evitare l'interferenza dell'anta in fase di apertura con cornici o mensole, si può richiedere il limitatore dell'angolo di apertura

In order to avoid that the door interferes with cornices or shelves during the opening movement, it is possible to request an opening angle limiter: code

**SCHEMA MONTAGGIO LIMITATORE PER RIBALTA H 36**  
FLAP DOOR LIMITER INSTALLATION DIAGRAM H 36

**SCHEMA MONTAGGIO LIMITATORE PER RIBALTA H 48**  
FLAP DOOR LIMITER INSTALLATION DIAGRAM H 48

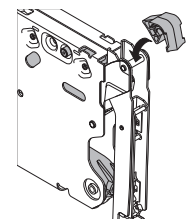
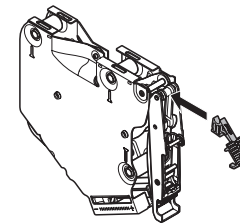

**APERTURA VERTICALE OBLIQUA**

I pensili con questo tipo di meccanismo necessitano per l'apertura di poco spazio libero sopra il mobile grazie al movimento basculante dell'anta che si apre senza difficoltà applicando poca forza anche in presenza di frontali pesanti. Con l'arresto progressivo le ante si fermano in qualsiasi posizione; in questo modo la maniglia è sempre facilmente raggiungibile. La chiusura è ammortizzata ed è possibile regolare la forza di tenuta in base al peso del frontale.

VERTICAL OPENING OBLIQUE

Wall units that mount this type of mechanism require little clearance above the cabinet thanks to the swivelling movement of the door that can be easily opened by applying slight pressure, even with heavy fronts. The doors stop in any position thanks to the gradual stopping movement; in this way, the handle is always easily accessible. The closing movement is cushioned and the closing force can be adjusted according to the weight of the front door.



**DI SERIE**  
STANDARD



**MOTORIZZATO**  
**SERVO-DRIVE**  
SERVO-DRIVE  
MOTORISED  
(Opz.007)

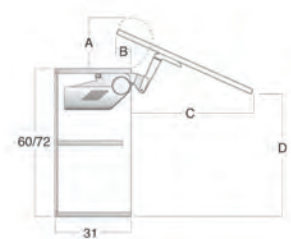

	A	B	C	D
H 60	18	9,6	46,5	53,5
H 72	18	9,6	57	61

**APERTURA VERTICALE**

L'anta ad apertura verticale, potendo essere sollevata completamente verso l'alto, consente un accesso totale all'interno del pensile. Ideale per l'impiego in mobili a colonna per nascondere ad esempio apparecchi elettrici, o pensili con corpi mobili sovrastanti, ha la chiusura ammortizzata e la possibilità di regolare la forza di tenuta in base al peso del frontale.

VERTICAL OPENING

Doors with vertical opening movement can be fully raised to fully access the inside of the wall unit.

Ideal for use on column units to conceal electrical appliances for examples, or on wall units surmounted by mobile units.

The closing movement is cushioned and the closing force can be adjusted according to the weight of the front door.



**DI SERIE  
STANDARD**

**MOTORIZZATO  
SERVO-DRIVE**  
SERVO-DRIVE  
MOTORISED  
(Opz.007)

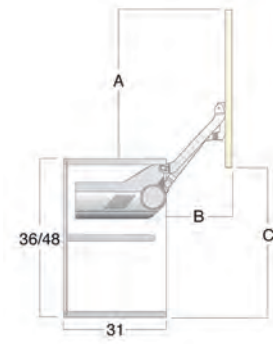

	A	B	C
H 36	34	23,5	34,5
H 48	43	28,5	43,5

**APERTURA ANTE A PACCHETTO**

Il meccanismo d'apertura ante a pacchetto è idoneo sul pensile H 72; la regolazione della forza di apertura può essere impostata in modo esatto in base ai pesi dei frontali, la chiusura è ammortizzata e la cerniera centrale clip si contraddistingue per l'innovativa tecnologia che garantisce la sicurezza per le dita.

LIFT-UP FOLDING DOORS

The lift-up folding door opening mechanism is suitable for wall units with H 72; the opening force can be adjusted precisely according to the weight of the fronts, while the closing movement is cushioned and the central clip-on hinge features innovative technology for safeguarding the fingers.



**DI SERIE  
STANDARD**

**MOTORIZZATO  
SERVO-DRIVE**  
SERVO-DRIVE  
MOTORISED  
(Opz.007)

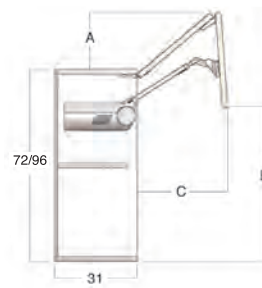

	A	B	C
H 72	16,5	54	41
H 96	20	69	53

**SCHEMA MONTAGGIO  
LIMITATORE**  
LIMITER INSTALLATION  
DIAGRAM

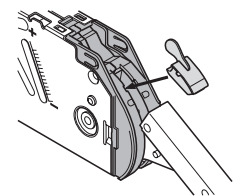

**Per evitare l'interferenza dell'anta in fase di apertura con cornici o mensole, si può richiedere il limitatore dell'angolo di apertura**

In order to avoid that the door interferes with cornices or shelves during the opening movement, it is possible to request an opening angle limiter:

## COLONNE ARMADIO “NOOK” H 217 P 70,6 CON ANTE A SCOMPARSA

“NOOK” CLOSET COLUMNS H 217 D 70,6 WITH DOORS INWARDS

Le colonne armadio “Nook” con ante a scomparsa, consentono di inserire all’interno forno, frigo, tavolo e cassetti

“Nook” closet columns with pull-out doors allow to insert oven, fridge, table and drawer on the inside



# COLONNE ARMADIO "NOOK" H 217 P 70,6 CON ANTE A SCOMPARSA

"NOOK" CLOSET COLUMNS H 217 D 70,6 WITH DOORS INWARDS

Il tavolo estraibile è disponibile nella versione inox o in laminato, nella finitura oak cognac

The pull-out table it's available in stainless steel version or laminate oak cognac finish







**ZOCCOLO**  
H 6 centimetri  
=  
più volume di  
contenimento

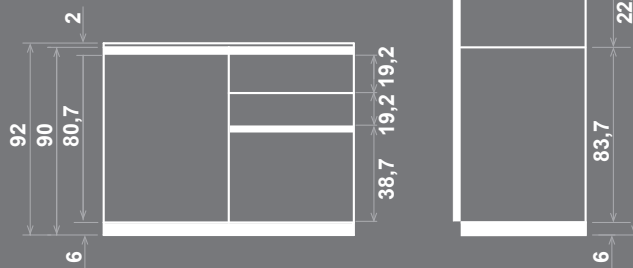

Con lo **zoccolo** ad altezza ridotta a 6 cm, si possono **guadagnare centimetri preziosi di contenimento**, dando alla cucina l'aspetto elegante di un living.

*Valuable space has been saved by lowering the plinth to 6 cm, and so the kitchen will take on a stylish look such as a living room.*



## strutture carcasses

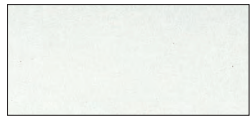

bianco (opz.001)  
schiena e ripiano bianco  
(opz.001)  
white  
white back panel and shelf



conchiglia (opz.8910)  
schiena e ripiano conchiglia  
(opz.8910)  
shell  
shell back panel and shelf



lavagna (opz.9620)  
schiena e ripiano lavagna  
(opz.9620)  
slate grey  
slate grey back panel and shelf



fango (opz.8860)  
schiena e ripiano fango  
(opz.8860)  
mud  
mud back panel and shelf



visone (opz.948M)  
schiena e ripiano visone  
(opz.948M)  
mink  
mink back panel and shelf



argilla (opz.9690)  
schiena e ripiano argilla  
(opz.9690)  
clay  
clay back panel and shelf



lino effetto tela (opz.8920)  
schiena e ripiano conchiglia  
(opz.8910)  
linen melamine-coated canvas  
effect (opt.8920)  
shell back panel and shelf  
(opt.8910)

## zoccoli in alluminio H 6 aluminium plinths H 6



alluminio finitura  
grafite (opz.421)  
aluminium graphite  
finish (opt.421)



alluminio finitura urban  
ossidato (opz.NU)  
aluminium urban  
oxidized finish (opt.NU)



alluminio finitura titanio  
ossidato (opz.414)  
aluminium titanium  
oxidized finish (opt.414)

N.B.: ABBINABILE CON L'ANTA  
LACCATA VINTAGE BRONZO BRUNITO  
NOTE: BEST MATCHING WITH THE  
BURNISHED LACQUERED VINTAGE  
BRONZE DOOR



alluminio finitura rame  
antico (opz.422)  
aluminium antique  
copper finish (opt.422)



alluminio finitura  
bronzo antico  
(opz.423)  
aluminium antique  
bronze finish (opt.423)

## zoccoli in alluminio H 6 verniciati a polvere finitura opaca

aluminum plinths H 6 powder coated matt finish



alluminio finitura  
grigio piombo  
(opz.9537)  
aluminium lead grey  
finish (opt.9537)



alluminio finitura nero  
(opz.7892)  
aluminium  
black finish (opt.7892)

N.B.: ABBINABILE CON L'ANTA  
LACCATA NERO SEPPIA  
NOTE: BEST MATCHING WITH THE  
LACQUERED CUTTLEFISH INK DOOR



alluminio finitura  
conchiglia (opz.7403)  
aluminium shell  
finish (opt.7403)



alluminio finitura  
silver dark (opz.9507)  
aluminium dark silver  
finish (opt.9507)

N.B.: ABBINABILE CON L'ANTA  
LACCATA GRIGIO QUARZO  
NOTE: BEST MATCHING WITH THE  
LACQUERED QUARTZ GREY DOOR



alluminio finitura rame  
(opz.8167)  
aluminium copper  
finish (opt.8167)



alluminio finitura  
ghisa (opz.9509)  
aluminium cast iron  
finish (opt.9509)



alluminio carbon  
(opz.W920)  
aluminium carbon  
(opt.W920)

N.B.: ABBINABILE CON L'ANTA  
LACCATA GRIGIO LAVA  
NOTE: BEST MATCHING WITH THE  
LACQUERED LAVA GREY DOOR



alluminio finitura  
polvere (opz.9539)  
aluminium dust  
finish (opt.9539)



alluminio grigio  
traffico (opz.9511)  
aluminium traffic grey  
finish (opt.9511)

N.B.: ABBINABILE CON L'ANTA  
LACCATA NEBBIA  
NOTE: BEST MATCHING WITH THE  
LACQUERED FOG DOOR



alluminio finitura  
argilla (opz.9503)  
aluminium clay  
finish (opt.9503)



alluminio mandorla  
(opz.W820)  
aluminium  
almond (opt.W820)

N.B.: ABBINABILE CON L'ANTA  
LACCATA GRIGIO REALE  
NOTE: BEST MATCHING WITH THE  
LACQUERED REAL GREY DOOR



alluminio finitura  
creta (opz.9515)  
aluminium clay  
finish (opt.9515)



alluminio finitura  
bianco assoluto  
(opz.740S)  
aluminium absolute  
white finish (opt.740S)



alluminio bistro  
(opz.9535)  
aluminium bistro  
finish (opt.9535)

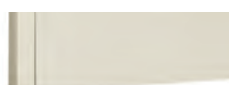

alluminio lino  
(opz.W770)  
aluminium linen  
(opt.W770)



alluminio finitura  
grigio selce (opz.SE)  
aluminium flint grey  
finish (opt.SE)



alluminio finitura  
cenere (opz.9547)  
aluminium ash  
finish (opt.9547)



alluminio finitura  
fumo (opz.9531)  
aluminium smoke  
finish (opt.9531)



alluminio finitura  
ottone (opz.7761)  
aluminium brass  
finish (opt.7761)

N.B.: ABBINABILE CON L'ANTA  
TELAIO VETRO TELAIO OTTONE  
NOTE: BEST MATCHING WITH THE  
GLASS DOOR WITH BRASS FRAME





**ZOCCOLO**  
H 6 centimetri  
=  
più volume di  
contenimento

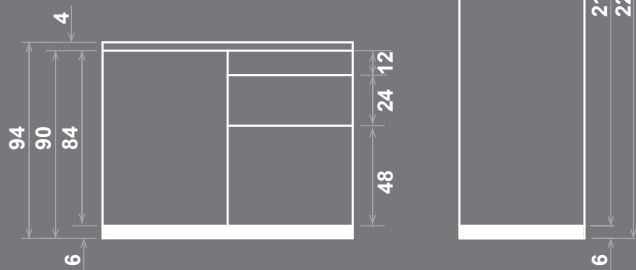

Con lo **zoccolo** ad altezza ridotta a 6 cm, si possono **guadagnare centimetri preziosi di contenimento**, dando alla cucina l'aspetto elegante di un living.

*Valuable space has been saved by lowering the **plinth** to 6 cm, and so the kitchen will take on a stylish look such as a living room.*



## strutture carcasses

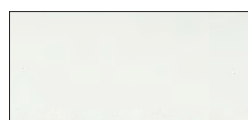

bianco (opz.001)  
schiena e ripiano bianco  
(opz.001)  
white  
white back panel and shelf

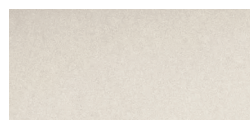

conchiglia (opz.8910)  
schiena e ripiano conchiglia  
(opz.8910)  
shell  
shell back panel and shelf



lavagna (opz.9620)  
schiena e ripiano lavagna  
(opz.9620)  
slate grey  
slate grey back panel and shelf



fango (opz.8860)  
schiena e ripiano fango  
(opz.8860)  
mud  
mud back panel and shelf



visone (opz.948M)  
schiena e ripiano visone  
(opz.948M)  
mink  
mink back panel and shelf



argilla (opz.9690)  
schiena e ripiano argilla  
(opz.9690)  
clay  
clay back panel and shelf



lino effetto tela (opz.8920)  
schiena e ripiano conchiglia  
(opz.8910)  
linen melamine-coated canvas  
effect (opt.8920)  
shell back panel and shelf  
(opt.8910)

## zoccoli in alluminio H 6 aluminium plinths H 6



alluminio finitura  
grafite (opz.421)  
aluminium graphite  
finish (opt.421)



alluminio finitura urban  
ossidato (opz.NU)  
aluminium urban  
oxidized finish (opt.NU)



alluminio finitura titanio  
ossidato (opz.414)  
aluminium titanium  
oxidized finish (opt.414)

N.B.: ABBINABILE CON L'ANTA  
LACCATA VINTAGE BRONZO BRUNITO  
NOTE: BEST MATCHING WITH THE  
BURNISHED LACQUERED VINTAGE  
BRONZE DOOR



alluminio finitura rame  
antico (opz.422)  
aluminium antique  
copper finish (opt.422)



alluminio finitura  
bronzo antico  
(opz.423)  
aluminium antique  
bronze finish (opt.423)

## zoccoli in alluminio H 6 verniciati a polvere finitura opaca aluminum plinths H 6 powder coated matt finish



alluminio finitura  
grigio piombo  
(opz.9537)  
aluminium lead grey  
finish (opt.9537)



alluminio finitura nero  
(opz.7892)  
aluminium  
black finish (opt.7892)

N.B.: ABBINABILE CON L'ANTA  
LACCATA NERO SEPIA  
NOTE: BEST MATCHING WITH THE  
LACQUERED CUTTLEFISH INK DOOR



alluminio finitura  
conchiglia (opz.7403)  
aluminium shell  
finish (opt.7403)



alluminio finitura  
silver dark (opz.9507)  
aluminium dark silver  
finish (opt.9507)

N.B.: ABBINABILE CON L'ANTA  
LACCATA GRIGIO QUARZO  
NOTE: BEST MATCHING WITH THE  
LACQUERED QUARTZ GREY DOOR



alluminio finitura rame  
(opz.8167)  
aluminium copper  
finish (opt.8167)



alluminio finitura  
ghisa (opz.9509)  
aluminium cast iron  
finish (opt.9509)



alluminio carbon  
(opz.W920)  
aluminium carbon  
(opt.W920)

N.B.: ABBINABILE CON L'ANTA  
LACCATA GRIGIO LAVA  
NOTE: BEST MATCHING WITH THE  
LACQUERED LAVA GREY DOOR



alluminio finitura  
polvere (opz.9539)  
aluminium dust  
finish (opt.9539)



alluminio grigio  
traffico (opz.9511)  
aluminium traffic grey  
finish (opt.9511)

N.B.: ABBINABILE CON L'ANTA  
LACCATA NEBBIA  
NOTE: BEST MATCHING WITH THE  
LACQUERED FOG DOOR



alluminio finitura  
argilla (opz.9503)  
aluminium clay  
finish (opt.9503)



alluminio mandorla  
(opz.W820)  
aluminium  
almond (opt.W820)

N.B.: ABBINABILE CON L'ANTA  
LACCATA GRIGIO REALE  
NOTE: BEST MATCHING WITH THE  
LACQUERED REAL GREY DOOR



alluminio finitura  
creta (opz.9515)  
aluminium clay  
finish (opt.9515)



alluminio finitura  
bianco assoluto  
(opz.740S)  
aluminium absolute  
white finish (opt.740S)



alluminio bistro  
(opz.9535)  
aluminium bistro  
finish (opt.9535)



alluminio lino  
(opz.W770)  
aluminium linen  
(opt.W770)



alluminio finitura  
grigio selce (opz.SE)  
aluminium flint grey  
finish (opt.SE)



alluminio finitura  
cenere (opz.9547)  
aluminium ash  
finish (opt.9547)



alluminio finitura  
fumo (opz.9531)  
aluminium smoke  
finish (opt.9531)



alluminio finitura  
ottone (opz.7761)  
aluminium brass  
finish (opt.7761)

N.B.: ABBINABILE CON L'ANTA  
TELAIO VETRO TELAIU OTTONE  
NOTE: BEST MATCHING WITH THE  
GLASS DOOR WITH BRASS FRAME







# CABINA RIPOSTIGLIO

CLOSET COLUMN



## COLORI ANTE CHIUSE E PANNELLI FISSI FRONTALE E LATERALE COLOURS FOR DOORS AND FIXED FRONT LATERAL PANELS



IMPIALLACCIATI A TELAIO **per colori vedi pag.12-13**  
VENEERED WITH FRAME **for colours see page 12-13**

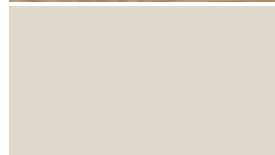

TELAIO LACCATO OPACO E LUCIDO **per colori vedi pag.18-22**  
MATT AND GLOSSY LACQUERED FRAME **for colours see page 18-22**



LISCIA LACCATA OPACA E LUCIDA **per colori vedi pag.28-29**  
MATT AND GLOSSY LACQUERED SMOOTH **for colours see page 28-29**



LACCATA LISCIA VINTAGE **per colori vedi pag.31**  
VINTAGE SMOOTH LACQUERED **for colours see page 31**

## ANTE VETRO GLASS DOORS

**N.B.: per colori vedi pag. 12-13**  
**NOTE: for colours see pages 12-13**



frassino nebbia (opz.2449),  
vetro extrachiaro (opz.CH)  
fog ash (opt.2449),  
extra-clear glass (opt.CH)



frassino nebbia (opz.2449),  
vetro fumè (opz.FM)  
fog ash (opt.2449),  
tinted glass (opt.FM)



frassino nebbia (opz.2449),  
vetro bronzo (opz.BZ)  
fog ash (opt.2449),  
bronze glass (opt.BZ)

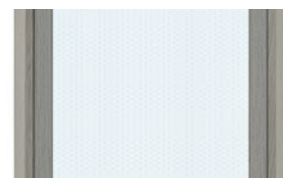

frassino nebbia (opz.2449),  
vetro extrachiaro  
serigrafato bianco, trama  
nido d'ape (opz.CHN)  
fog ash (opt.2449),  
ultra-clear screen-printed  
white glass with honeycomb  
pattern (opt.CHN)



frassino nebbia (opz.2449),  
vetro fumè serigrafato  
bianco, trama nido d'ape  
(opz.FMN)  
fog ash (opt.2449),  
tinted screen-printed white  
glass with honeycomb  
pattern (opt.FMN)



frassino nebbia (opz.2449),  
vetro bronzo serigrafato  
bianco, trama nido d'ape  
(opz.BZN)  
fog ash (opt.2449),  
bronze screen-printed white  
glass with honeycomb  
pattern (opt.BZN)

## COLORI STRUTTURA INTERNA IN NOBILITATO COLOURS FOR INTERNAL MELAMINE-COATED STRUCTURE

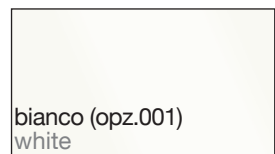

bianco (opz.001)  
white

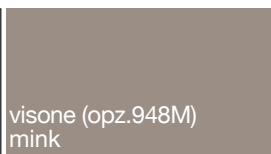

visone (opz.948M)  
mink

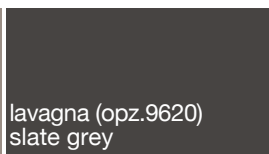

lavagna (opz.9620)  
slate grey

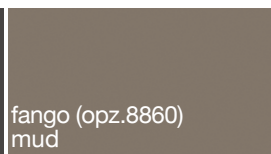

fango (opz.8860)  
mud

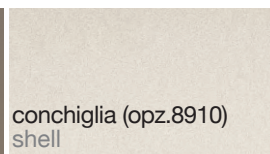

conchiglia (opz.8910)  
shell

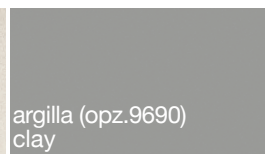

argilla (opz.9690)  
clay



lino effetto tela (opz.8920)  
linen melamin-coated canvas

# ELEMENTI A GIORNO IN ALLUMINIO "CLASS" RIPIANI VETRO EXTRACHIARO CON LUCE LED

"CLASS" ALUMINIUM OPEN UNITS, EXTRA-CLEAR GLASS SHELVES WITH LED LIGHT



## A RICHIESTA ON REQUEST

Particolare del ripiano con luce  
Detail of the shelf with light

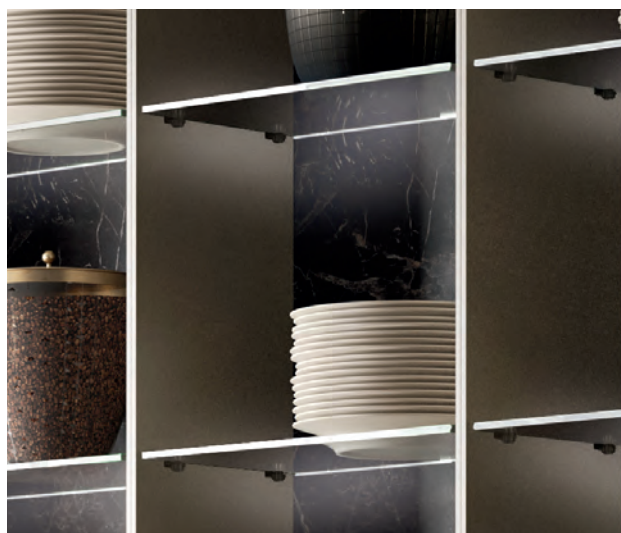

Disponibile luce calda e luce naturale  
Warm light and natural light available

Comando wireless "Pollicino" cod.08616078  
"Pollicino" wireless control



Un comando wireless "Pollicino" può accendere tutti gli elementi a giorno "CLASS" presenti all'interno di una stanza. Ogni pensile deve obbligatoriamente essere dotato di ricevitore Dimmer, (vedi maggiorazione pag.335)

A "Pollicino" wireless control can turn on all the "CLASS" open elements present inside a room. Each wall unit must be equipped with a Dimmer receiver, (see surcharge on page 335)

## COLORI STRUTTURA CARCASS COLOURS



rame (opz.RAME)  
copper

ottone anticato (opz.OTAN)  
antiqued brass

nero (opz.NERO)  
black

## COLORI SCHIENA EFFETTO MARMO BACK PANEL COLOURS WITH MARBLE EFFECT

di serie:  
standard

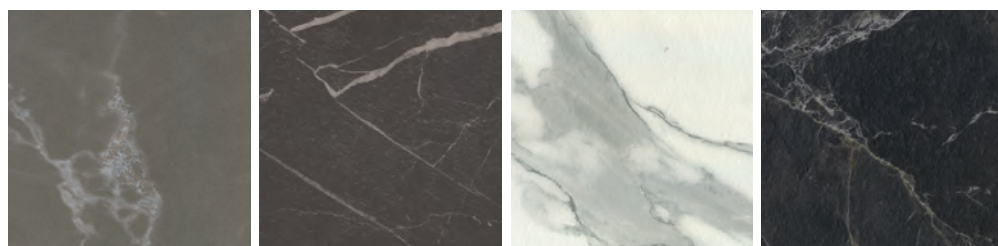

perlato finitura ker  
(opz.3443)  
pearly with ker finish

alabastro finitura mn  
(opz.6014)  
alabaster with mn finish

calacatta finitura mn  
(opz.6019)  
calacatta with mn finish

dark finitura mn  
(opz.6133)  
dark with mn finish

## COLORI SCHIENA LACCATO OPACO BACK PANEL WITH MATT LACQUERED COLOURS

### COLORI FREDDI OPACHI SOFT SOFT MATT COLD COLOURS

[CLICCA QUI PER LA GAMMA COLORI DISPONIBILI](#)

[CLICK HERE FOR THE RANGE OF AVAILABLE COLORS](#)

### COLORI CALDI OPACHI SOFT SOFT MATT HOT COLOURS

[CLICCA QUI PER LA GAMMA COLORI DISPONIBILI](#)

[CLICK HERE FOR THE RANGE OF AVAILABLE COLORS](#)

# MOBILI A GIORNO "MIND"

"MIND" OPEN ELEMENTS



## COLORI TELAIO E MENSOLE FRAME AND SHELVES COLOURS

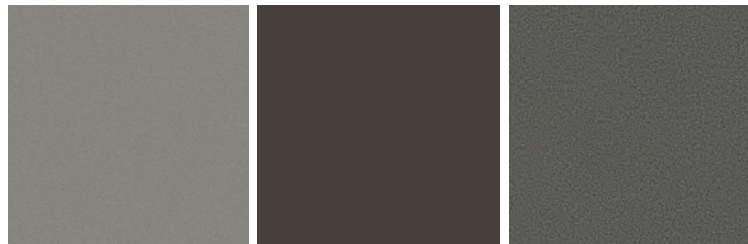

grigio selce (opz.GS)  
flint grey

ghisa (opz.GH)  
cast iron

silver dark (opz.S)  
dark silver

## COLORI SCHIENALI E STRUTTURE IMPIALLACCIATI BACK PANELS AND CARCASSES VENEERED COLOURS

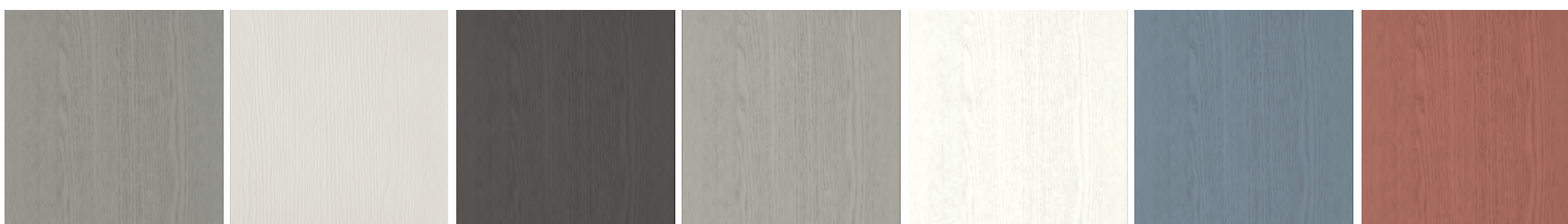

frassino grigio reale (opz.2450)  
royal grey ash

frassino lino (opz.2470)  
linen ash

frassino grigio lava (opz.2447)  
lava grey ash

frassino nebbia (opz.2449)  
fog ash

frassino bianco assoluto (opz.2466)  
absolute white ash

frassino azzurro nube (opz.2467)  
cloud blue ash

frassino rosso persia (opz.2468)  
persia red ash



frassino nero seppia (opz.2469)  
cuttlefish ink ash

rovere nuvola (opz.5375)  
cloud oak

rovere calce (opz.5376)  
lime oak

rovere cuoio (opz.5379)  
leather oak

rovere mielato (opz.5377)  
honey oak

rovere asfalto (opz.5378)  
asphalt oak

## COLORI SCHIENALI E STRUTTURE OPACHI BACK PANELS AND CARCASSES MATT COLOURS

[CLICCA QUI PER LA GAMMA COLORI DISPONIBILI](#)

[CLICK HERE FOR THE RANGE OF AVAILABLE COLORS](#)

## COLORI SCHIENE EFFETTO MARMO BACK PANELS COLOURS MARBLE EFFECT COLOURS

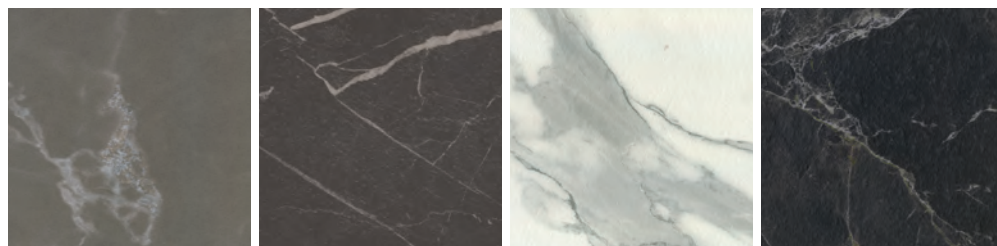

perlatto finitura ker  
(opz.3443)  
pearly with ker finish

alabastro finitura mn  
(opz.6014)  
alabaster with mn finish

calacatta finitura mn  
(opz.6019)  
calacatta with mn finish

dark finitura mn  
(opz.6133)  
dark with mn finish

# ELEMENTI A GIORNO IN LAMIERA VERNICIATI A POLVERE SP.2 MM

POWDER PAINTED METAL SHEET OPEN UNITS TH.2 MM



## COLORI OPACHI MATT COLOURS

# ELEMENTI A GIORNO SP. 14 MM

OPEN ELEMENTS TH.14 MM



## COLORI IMPIALLACCIATI VENEERED COLOURS



frassino grigio reale  
(opz.2450)  
royal grey ash



frassino lino (opz.2470)  
linen ash



frassino grigio lava  
(opz.2447)  
lava grey ash



frassino nebbia  
(opz.2449)  
fog ash

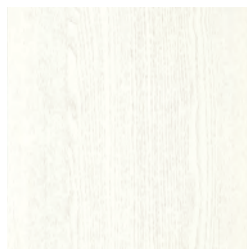

frassino bianco assoluto  
(opz.2466)  
absolute white ash

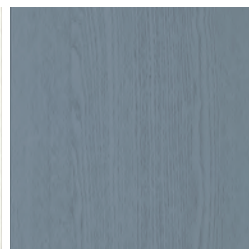

frassino azzurro nube  
(opz.2467)  
cloud blue ash



frassino rosso persia  
(opz.2468)  
persia red ash



frassino nero seppia  
(opz.2469)  
cuttlefish ink ash



rovere nuvola (opz.5375)  
cloud oak



rovere calce (opz.5376)  
lime oak



rovere cuoio (opz.5379)  
leather oak



rovere mielato (opz.5377)  
honey oak



rovere asfalto (opz.5378)  
asphalt oak

## COLORI OPACHI MATT COLOURS

---

 [CLICCA QUI PER LA GAMMA COLORI DISPONIBILI](#)

 [CLICK HERE FOR THE RANGE OF AVAILABLE COLORS](#)



# ELEMENTI A GIORNO "CODE"

"CODE" OPEN UNITS

---



## COLORI MONTANTI IN METALLO COLOURS METAL ELEMENTS

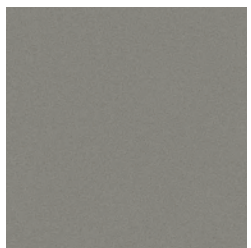

grigio selce (opz.95SE)  
flint grey

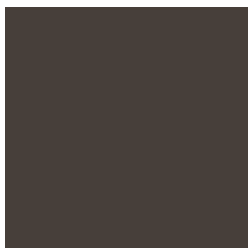

ghisa (opz.9509)  
cast iron



nero (opz.7892)  
black

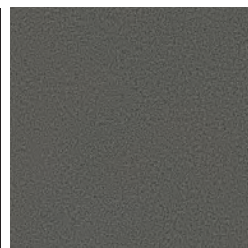

silver dark (opz.9507)  
dark silver

## COLORI MENSOLE IMPIALLACCIATO VENEERED COLOURS SHELVES



frassino grigio reale  
(opz.2450)  
royal grey ash



frassino lino (opz.2470)  
linen ash



frassino grigio lava  
(opz.2447)  
lava grey ash



frassino nebbia  
(opz.2449)  
fog ash

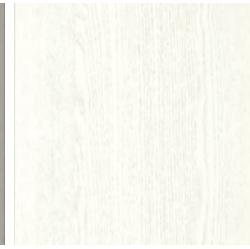

frassino bianco assoluto  
(opz.2466)  
absolute white ash



frassino azzurro nube  
(opz.2467)  
cloud blue ash

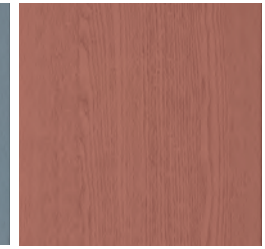

frassino rosso persia  
(opz.2468)  
persia red ash



frassino nero seppia  
(opz.2469)  
cuttlefish ink ash

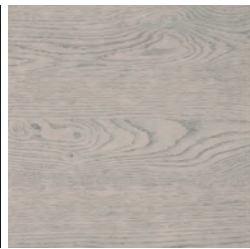

rovere nuvola (opz.5375)  
cloud oak



rovere calce (opz.5376)  
lime oak

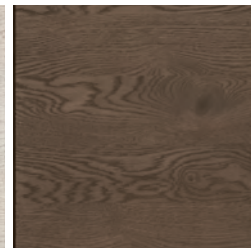

rovere cuoio (opz.5379)  
leather oak



rovere mielato (opz.5377)  
honey oak

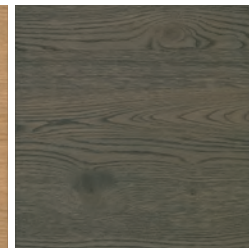

rovere asfalto (opz.5378)  
asphalt oak

## COLORI MENSOLE LACCATO OPACO MATT LACQUERED COLOURS SHELVES

### COLORI FREDDI OPACHI SOFT SOFT MATT COLD COLOURS



CLICCA QUI PER LA GAMMA COLORI DISPONIBILI



CLICK HERE FOR THE RANGE OF AVAILABLE COLORS

### COLORI CALDI OPACHI SOFT SOFT MATT HOT COLOURS



CLICCA QUI PER LA GAMMA COLORI DISPONIBILI



CLICK HERE FOR THE RANGE OF AVAILABLE COLORS

# LIBRERIA "CODE"

"CODE" BOOKCASE

---



## COLORI MONTANTI IN METALLO

COLOURS METAL ELEMENTS



grigio selce (opz.95SE)  
flint grey

ghisa (opz.9509)  
cast iron

nero (opz.7892)  
black

silver dark (opz.9507)  
dark silver

## COLORI MENSOLE IMPIALLACCIATO VENEERED COLOURS SHELVES



frassino grigio reale  
(opz.2450)  
royal grey ash

frassino lino (opz.2470)  
linen ash

frassino grigio lava  
(opz.2447)  
lava grey ash

frassino nebbia  
(opz.2449)  
fog ash

frassino bianco assoluto  
(opz.2466)  
absolute white ash

frassino azzurro nube  
(opz.2467)  
cloud blue ash

frassino rosso persia  
(opz.2468)  
persia red ash



frassino nero seppia  
(opz.2469)  
cuttlefish ink ash

rovere nuvola (opz.5375)  
cloud oak

rovere calce (opz.5376)  
lime oak

rovere cuoio (opz.5379)  
leather oak

rovere mielato (opz.5377)  
honey oak

rovere asfalto (opz.5378)  
asphalt oak

## COLORI MENSOLE LACCATO OPACO MATT LACQUERED COLOURS SHELVES

### COLORI FREDDI OPACHI SOFT SOFT MATT COLD COLOURS

[CLICCA QUI PER LA GAMMA COLORI DISPONIBILI](#)

[CLICK HERE FOR THE RANGE OF AVAILABLE COLORS](#)

### COLORI CALDI OPACHI SOFT SOFT MATT HOT COLOURS

[CLICCA QUI PER LA GAMMA COLORI DISPONIBILI](#)

[CLICK HERE FOR THE RANGE OF AVAILABLE COLORS](#)

# VETRINA CON BASAMENTO IN METALLO

DISPLAY CABINET WITH METAL BASEMENT



## COLORI SCOCCA ESTERNA COLOUR FOR EXTERNAL CARCASS



IMPIALLACCIATO **colori pag.12-13**  
VENEERED **colours page 12-13**

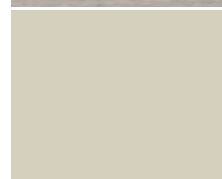

LACCATO OPACO **colori pag.18-28**  
MATT LACQUERED **colours page 18-28**



LACCATO LUCIDO **colori pag.22-29**  
GLOSSY LACQUERED **colours page 22-29**

## ANTA VETRO GLASS DOOR



IMPIALLACCIATO **colori pag.14-15**  
VENEERED **colours page 14-15**



LACCATO TELAIO OPACO **colori pag.19**  
FRAME MATT LACQUERED **colours page 19**



TELAIO ALLUMINIO **colori pag.32-33**  
ALUMINIUM FRAME **colours page 32-33**



LACCATO TELAIO LUCIDO **colori pag.23**  
FRAME GLOSSY LACQUERED **colours page 23**

## COLORI BASAMENTO COLOURS BASAMENT

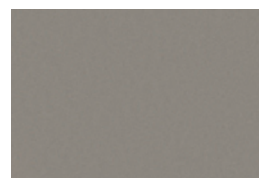

grigio selce (opz.SERB)  
flint grey



ghisa (opz.GHRB)  
cast iron

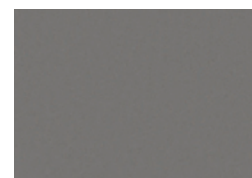

silver dark (opz.DARF)  
dark silver

# MOBILE DI FINITURA "SIDE"

"SIDE" FINISHING FURNITURE



## COLORI DIVISORI VETRI GLASS DIVIDERS COLOURS

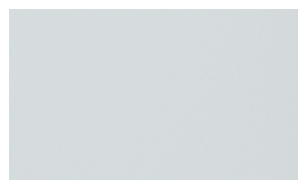

vetro satinato  
satin glass



vetro bronzo  
bronze glass



vetro fumè  
fumè glass

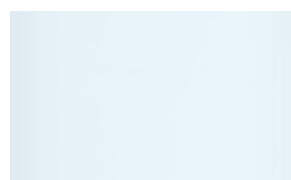

vetro extrachiaro  
extra-clear glass

## COLORI STRUTTURA E COLORI DIVISORI LACCATI OPACHI CARCASS COLOURS AND MATT LACQUERED DIVIDERS COLOURS

### COLORI FREDDI OPACHI SOFT SOFT MATT COLD COLOURS

 [CLICCA QUI PER LA GAMMA COLORI DISPONIBILI](#)

 [CLICK HERE FOR THE RANGE OF AVAILABLE COLORS](#)

### COLORI CALDI OPACHI SOFT SOFT MATT HOT COLOURS

 [CLICCA QUI PER LA GAMMA COLORI DISPONIBILI](#)

 [CLICK HERE FOR THE RANGE OF AVAILABLE COLORS](#)

# MOBILI PER LIVING "STYLE-F"

"STYLE-F" FURNITURE FOR LIVING



## COLORI SCOCCA ESTERNA COLOUR FOR EXTERNAL CARCASS



**IMPIALLACCIATO colori pag.12-13**  
VENEERED colours page 12-13

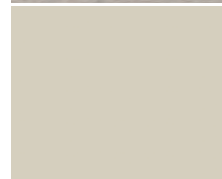

**LACCATO OPACO colori pag.18-28**  
MATT LACQUERED colours page 18-28

## ANTE DOORS



**IMPIALLACCIATE colori pag.12-13**  
VENEERED colours page 12-13

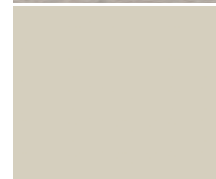

**LACCATO TELAIO OPACO colori pag.18**  
FRAME MATT LACQUERED colours page 18



**LACCATO LISCIO OPACO colori pag.28**  
SMOOTH MATT LACQUERED colours page 28

## ANTE VETRO GLASS DOORS



**IMPIALLACCIATO colori pag.14-15**  
VENEERED colours page 14-15



**LACCATO TELAIO OPACO colori pag.19**  
FRAME MATT LACQUERED colours page 19

## COLORI BASAMENTO COLOURS BASAMENT

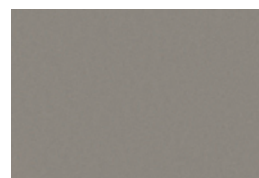

grigio selce (opz.SERB)  
flint grey



ghisa (opz.GHRB)  
cast iron

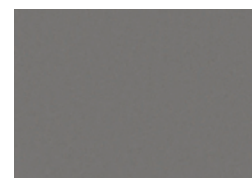

silver dark (opz.DARF)  
dark silver



# VIVI IL LIVING

LIVE THE LIVING

Con i nuovi pensili più profondi  
è facilissimo creare composizioni living  
adatte ad ogni spazio.

With new more deep wall units,  
it's easy to create lively  
furnishing compositions.



# LIVING LF01



ANTA  
door

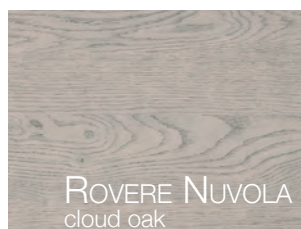

IMPIALLACCIATO  
veneered

ROVERE NUVOLA  
cloud oak

SCHIENALE  
back panel

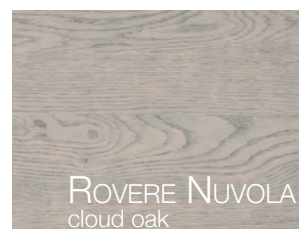

IMPIALLACCIATO  
veneered

ROVERE NUVOLA  
cloud oak

STRUTTURA  
carcass



VISONE  
mink

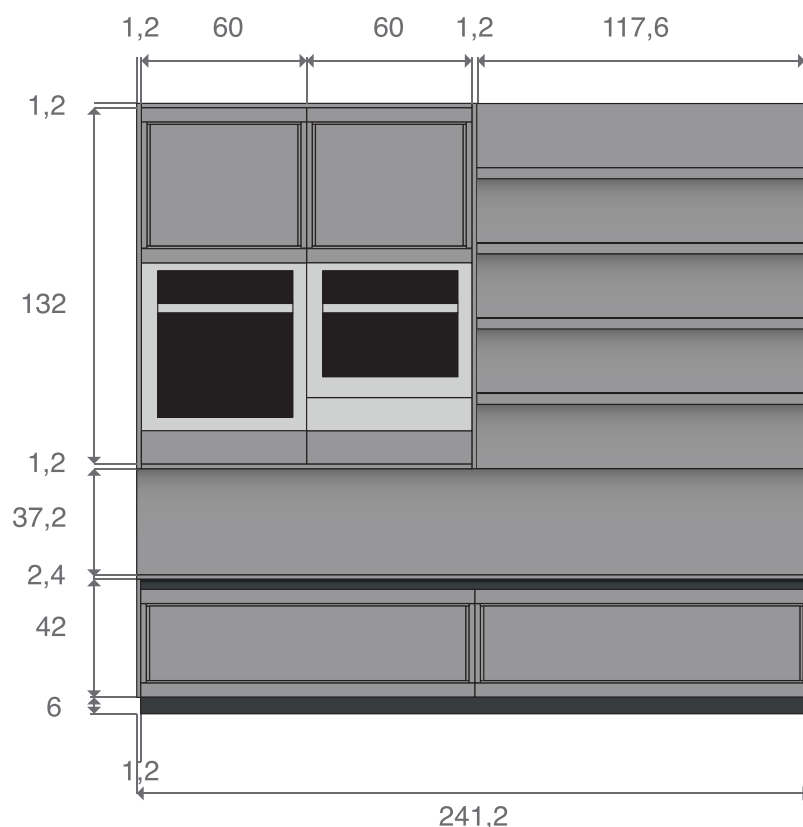

NR. ELEMENTI	DESCRIZIONE	CODICE
2	Colonna sospesa predisposta forno L 60 H 132 P 60,1 cassetto tip-on	E6576611/2
2	Anta di finitura laterale H 132 P 60,2 SP. 1,2 impiallacciata come anta	1N25410
2	Top living L 120 P 60,2 SP. 1,2 impiallacciata come anta	al ml TIL129
2	Base living L 120 H 42 P 60,1 cestone	GB205200
1	Anta di finitura laterale H 42 P 60,2 SP. 1,2 impiallacciata come anta	1N253958
1	Top living L 241,2 P 60,2 SP. 2,4 impiallacciata come anta	al ml TIL249
1	Schienale L 117,6 H 134,4 SP. 2,4 impiallacciato come anta	al mq 094523F
1	Schienale L 240 H 37,2 SP. 2,4 impiallacciato come anta	al mq 094523F
4	Mensole L 117,6 P 31 SP. 3,8 impiallacciato come anta	al ml 091723
1	Zoccolo alluminio L 240+52 H 6 laccato opaco a polvere	al ml 092085
1	Angolare per zoccolo H 6	0923903

No. of ELEMENTS	DESCRIPTION	CODE
2	Hanging oven column W 60 H 132 D 60,1 drawer tip-on opening	E6576611/2
2	Veneered lateral finishing door H 132 D 60,2 TH. 1,2 same colour as door	1N25410
2	Veneered living worktop W 120 D 60,2 TH. 1,2 same colour as door	per lm TIL129
2	Living base unit W 120 H 42 D 60,1 deep drawer	GB205200
1	Veneered lateral finishing door H 42 D 60,2 TH. 1,2 same colour as door	1N253958
1	Veneered living worktop W 241,2 D 60,2 TH. 2,4 same colour as door	per lm TIL249
1	Veneered back panel W 117,6 H 134,4 TH. 2,4 same colour as door	per m <sup>2</sup> 094523F
1	Veneered back panel W 240 H 37,2 TH. 2,4 same colour as door	per m <sup>2</sup> 094523F
4	Veneered shelf W 117,6 D 31 TH. 3,8 same colour as door	per lm 091723
1	Aluminium plinth W 240+52 H 6 powder coated matt finish	per lm 092085
1	Angular for plinth H 6	0923903

# LIVING LF02



ANTA  
door

SCHIENALE  
back panel

STRUTTURA  
carcass

IMPIALLACCIATO  
veneered

LACCATO OPACO  
matt lacquered



GRIGIO REALE  
royal grey



GRIGIO REALE  
royal grey



VISONE  
mink

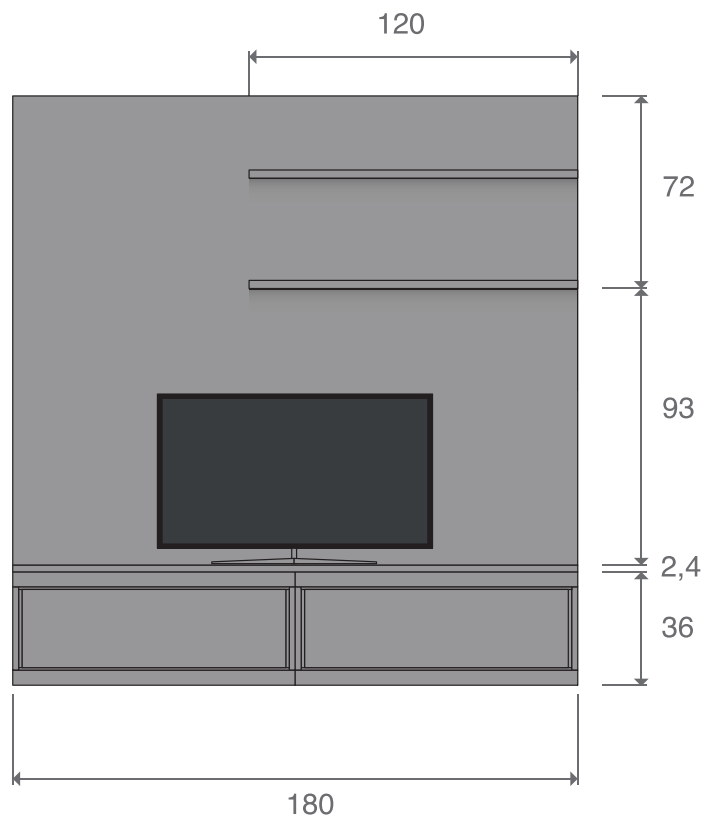

NR. ELEMENTI	DESCRIZIONE	CODICE
2	Base living sospesa L 90 H 36 P 60,1 cestone apertura tip-on	E4311900
1	Top L 180 P 60,2 H 2,4 impiallacciato come anta	al ml TIL249
1	Schienale L 180 H 72 SP. 2,4 laccato come anta	al mq 094535
1	Schienale L 180 H 93 SP. 2,4 laccato come anta	al mq 094535
2	Mensola L 120 P 31 SP. 3,8 laccato come anta	al ml 091733

No. of ELEMENTS	DESCRIPTION	CODE
2	Hanging living base unit W 90 H 36 D 60,1 deep drawer tip-on opening	E4311900
1	Veneered worktop W 180 D 60,2 H 2,4 same colour as door	per lm TIL249
1	Lacquered back panel W 180 H 72 TH. 2,4 same colour as door	per m <sup>2</sup> 094535
1	Lacquered back panel W 180 H 93 TH. 2,4 same colour as door	per m <sup>2</sup> 094535
2	Lacquered shelf W 120 D 31 TH. 3,8 same colour as door	per lm 091733

# LIVING LF03



ANTA  
door

ROVERE  
oak

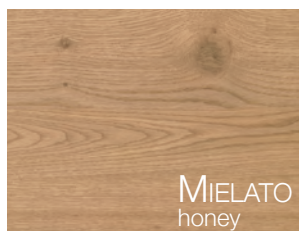

ELEMENTI A GIORNO  
open units

STRUTTURA  
carcass



STRUTTURA  
carcass

SCHIENA  
back panel  
LACCATO OPACO  
matt lacquered



SCHIENA  
back panel  
IMPIALLACCIATO  
veneered

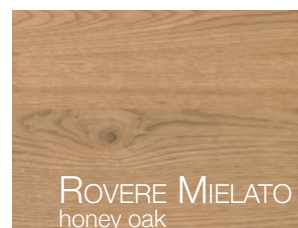

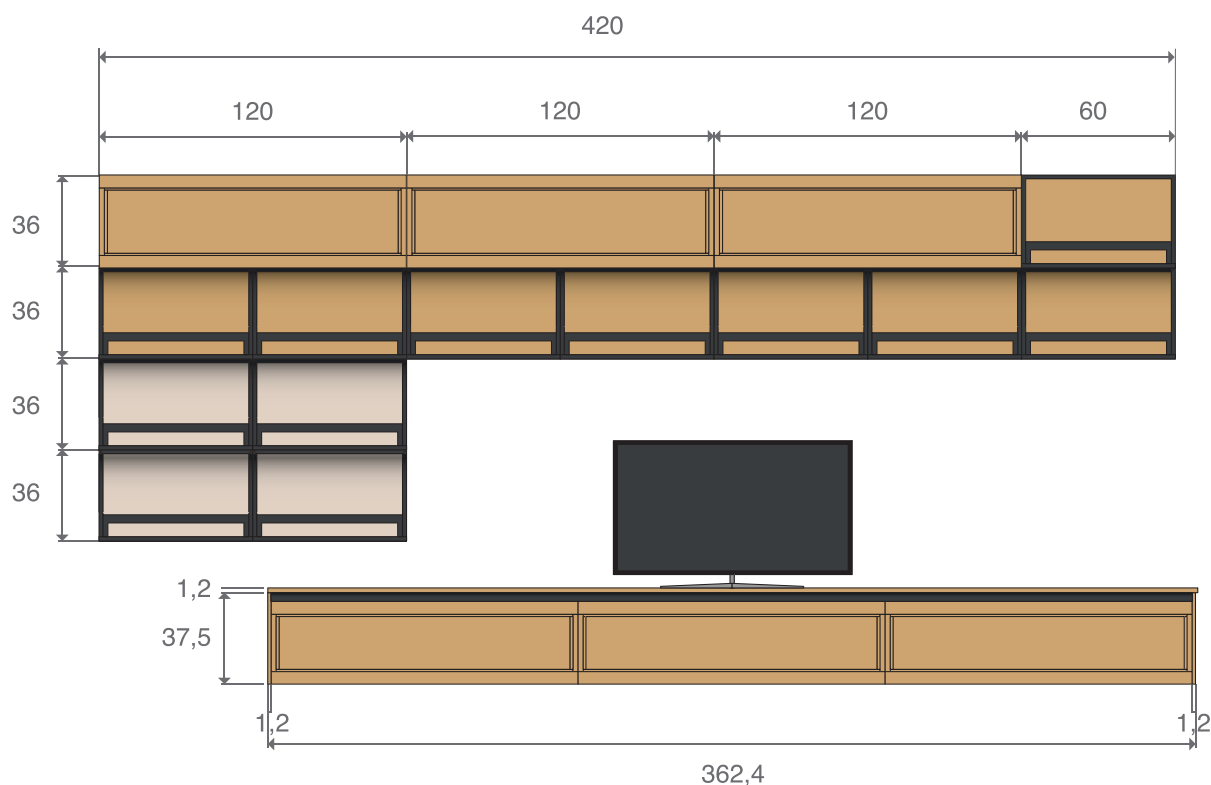

NR. ELEMENTI	DESCRIZIONE	CODICE
3	Base living sospesa L 120 H 37,5 P 50,6 cestone	GBL76200
2	Fianco living P 50,7 H 37,5 SP. 1,2 impiallacciato come anta	al ml TIL127F
1	Top L 241,2 P 50,7 H 1,2 impiallacciato come anta	al ml TIL127
1	Top L 121,2 P 50,7 H 1,2 impiallacciato come anta	al ml TIL127
2	Pensile L 120 H 36 P 33,6 ribalta apertura tip-on, fianco come anta	E210120T
1	Pensile L 120 H 36 P 33,6 ribalta apertura tip-on	E210120T
8	Elemento a giorno "MIND" L 60 H 36 P 24 schiena impiallacciata come anta	E8370636
4	Elemento a giorno "MIND" L 60 H 36 P 24 schiena laccata opaca	E8370636
2	Asta appendipensili ml 2	08610501

No. of ELEMENTS	DESCRIPTION	CODE
3	Hanging living base unit W 120 H 37,5 D 50,6 deep drawer	GBL76200
2	Veneered living side D 50,7 H 37,5 TH.1,2 same colour as door	per lm TIL127F
1	Veneered living worktop W 241,2 D 50,7 TH. 1,2	per lm TIL127
1	Veneered living worktop W 121,2 D 50,7 TH. 1,2	per lm TIL127
2	Wall unit W 120 H 36 D 33,6 flap door tip-on opening, side same as door	E210120T
1	Wall unit W 120 H 36 D 33,6 flap door tip-on opening	E210120T
8	Open unit "MIND" W 60 H 36 D 24 veneered back panel	E8370636
4	Open unit "MIND" W 60 H 36 D 24 lacquered back panel	E8370636
2	Wall unit fixing strip lm 2	08610501

# LIVING LF04



ANTA  
door

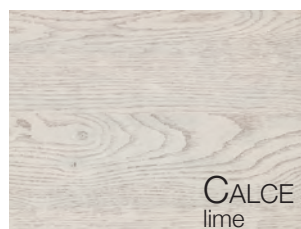

ROVERE  
oak

CALCE  
lime

ELEMENTI A GIORNO  
open units



RAME  
copper

STRUTTURA  
carcass



CONCHIGLIA  
shell

STRUTTURA  
carcass

SCHIENA  
back  
pannel



CALACATTA FINITURA MN  
calacatta mn finish



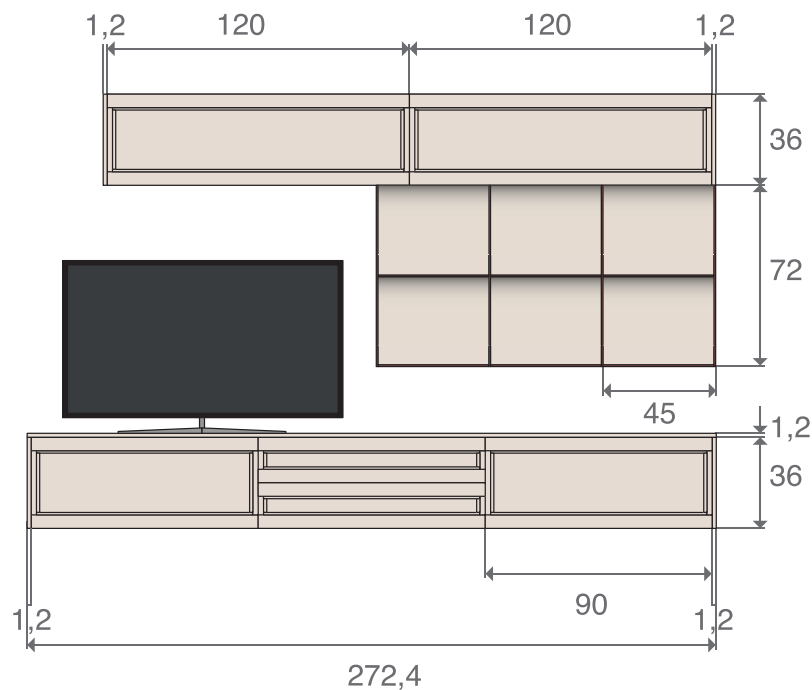

NR. ELEMENTI	DESCRIZIONE	CODICE
2	Pensile L 120 H 36 P 33,6 apertura tip-on	E210120T
2	Anta di finitura P 33,7 H 36 SP. 1,2	1B254045
2	Base living sospesa L 90 H 36 P 50,6	EBL75900
1	Base living sospesa L 90 H 36 P 50,6 2 cassetti	EBL73900
3	Pensili a giorno "CLASS" L 45 H 72 P 26 schiena effetto marmo	E7710222
1	Top living L 272,4 P 50,8 SP. 1,2 impiallacciato come anta	al ml TIL127
2	Fianco living P 50,8 H 36 SP. 1,2 impiallacciato come anta	al ml TIL127F
2	Asta appendipensili ml 2	08610501
No. of ELEMENTS	DESCRIPTION	CODE
2	Wall unit W 120 H 36 D 33,6 flap door tip-on opening	E210120T
2	Finishing door D 33,7 H 36 TH. 1,2	1B254045
2	Hanging living base unit W 90 H 36 D 50,6	EBL75900
1	Hanging living base unit W 90 H 36 D 50,6 2 drawers	EBL73900
3	Open wall unit "CLASS" W 45 H 72 D 26 with back panel marble effect	E7710222
1	Veneered living worktop W 272,4 D 50,8 TH. 1,2 same colour as door	per lm TIL127
2	Veneered living side D 50,8 H 36 TH. 1,2 same colour as door	per lm TIL127F
2	Wall unit fixing strip lm 2	08610501

# LIVING A SPALLA LF05



ANTA  
door

SCHIENA  
back panel

STRUTTURE  
carcasses

LACCATO OPACO  
matt lacquered

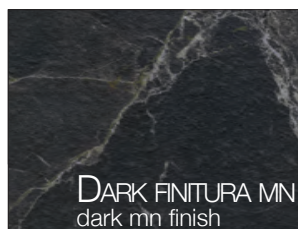
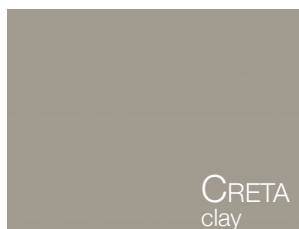

NOBILITATO  
melamine-coated

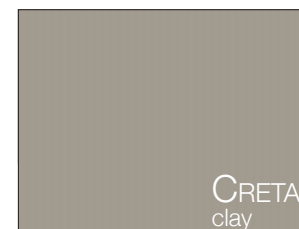

LACCATO OPACO  
matt lacquered

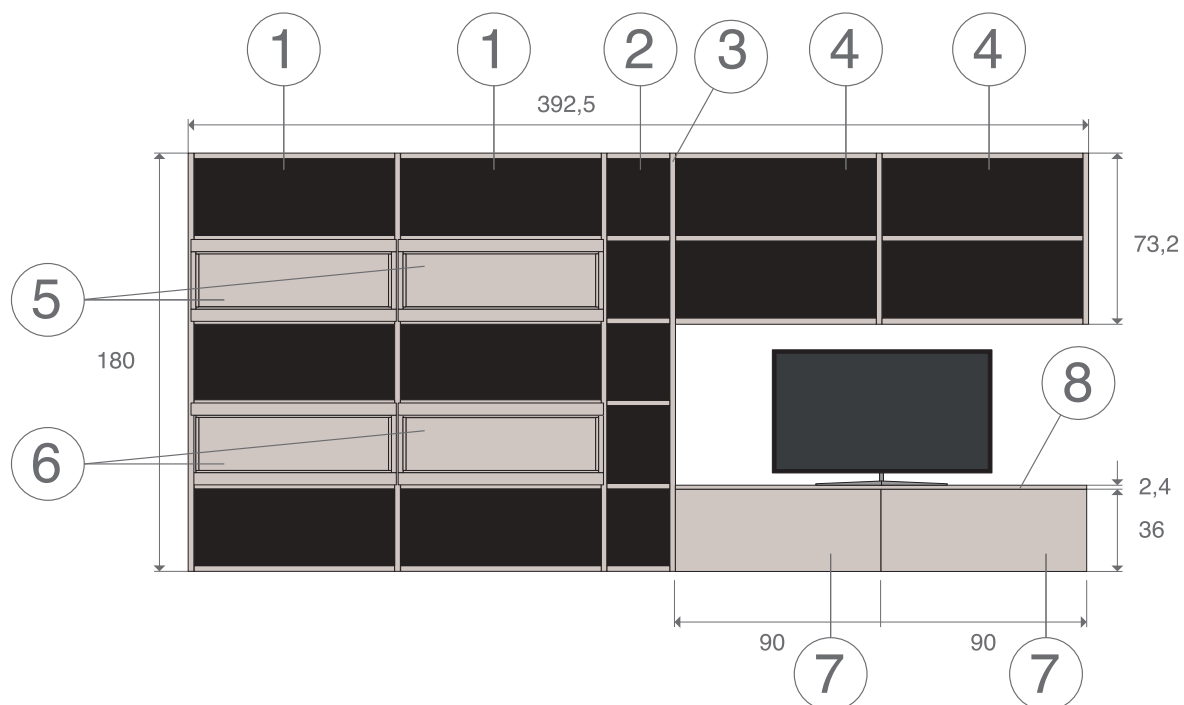

## COMPOSIZIONE L 305

COMPOSITION W 305



## COMPOSIZIONE L 423

COMPOSITION W 423



## COMPOSIZIONE L 305

COMPOSITION W 305

### COMPONENTI COMPONENTS

**Colonna 60 H 217 frigo-freezer 230 classe A+ con gola verticale e fianco come anta**

60 cm column H 217 fridge-freezer 230 class "A+" with vertical finger rail and side as doors

**Base 60**

60 cm base unit

**Base 60 forno multifunzione inox**

60 cm base unit for stainless steel multifunctional oven

**Piano cottura 60 4 gas inox con valvola**

60 cm stainless steel hob with 4 burners with safety valve

**Base 60 2 cassetti e cestone**

60 cm base unit with 2 drawers and deep drawer

**Sottolavello 60**

60 cm sink unit

**Lavello ad incasso 86 x 50 1 vasca inox**

86x50 cm built-in sink with 1 stainless steel bowl

**Top 240 P 61 in laminato H 4**

240 cm laminate worktop D 61 H 4

**Pensile 60 H 72**

60 cm wall unit H 72

**Cappa 60 "Mod. 29" H 72**

60 cm hood "Mod.29" H 72

**Pensile 60 H 72**

60 cm wall unit H 72

**Scolapiatti 60 H 72**

60 cm plate rack H 72

**Asta appendispensili ml 4**

4 lm wall unit fixing strip

**(Elettrodomestici Hotpoint )**

(Hotpoint appliances)

## COMPOSIZIONE L 423

COMPOSITION W 423

### COMPONENTI COMPONENTS

**Colonna 60 H 217 frigo-freezer 315 classe A+**

60 cm column H 217 fridge-freezer 315 class "A+"

**Colonna 60 H 217 forno multifunzione inox**

60 cm column H 217 for stainless steel multifunctional oven

**Base 60**

60 cm base unit

**Piano cottura 75 5 gas inox con valvola**

75 cm stainless steel hob with 5 burners with safety valve

**Base 90 2 cassetti e cestone predisposta piano cottura**

90 cm base unit with 2 drawers and deep drawers configured for hob

**Base 60**

60 cm base unit

**Sottolavello 90**

90 cm sink unit

**Lavello ad incasso 86 x 50 1 vasca inox**

86x50 cm built-in sink with 1 stainless steel bowl

**Top 300 P 61 in laminato H 4**

300 cm laminate worktop D 61 H 4

**Pensile 60 H 72**

60 cm wall unit H 72

**Cappa 90 "STILO" inox**

90 cm "STILO" stainless steel hood

**Pensile 60 H 72**

60 cm wall unit H 72

**Scolapiatti 90 H 72**

90 cm plate rack H 72

**Asta appendispensili ml 4**

4 lm wall unit fixing strip

**(Elettrodomestici Hotpoint )**

(Hotpoint appliances)

## COMPOSIZIONE L 300

COMPOSITION W 300



## COMPOSIZIONE L 420

COMPOSITION W 420



## COMPOSIZIONE L 300

COMPOSITION W 300

### COMPONENTI COMPONENTS

**Colonna 60 H 217 frigo-freezer 230 classe A+**

60 cm column H 217 fridge-freezer 230 class "A+"

**Base 60**

60 cm base unit

**Base 60 forno multifunzione inox**

60 cm base unit for stainless steel multifunctional oven

**Piano cottura 60 4 gas inox con valvola**

60 cm stainless steel hob with 4 burners with safety valve

**Base 60 2 cassetti e cestone**

60 cm base unit with 2 drawers and deep drawer

**Sottolavello 60**

60 cm sink unit

**Lavello ad incasso 86 x 50 1 vasca inox**

86x50 cm built-in sink with 1 stainless steel bowl

**Top 240 P 61 in laminato H 4**

240 cm laminate worktop D 61 H 4

**Pensile 60 H 72**

60 cm wall unit H 72

**Cappa 60 aspirante estraibile H 63**

60 cm hood slide-out ducting H 63

**Pensile 60 H 72**

60 cm wall unit H 72

**Scolapiatti 60 H 72**

60 cm plate rack H 72

**Asta appendipensili ml 4**

4 lm wall unit fixing strip

**(Elettrodomestici Hotpoint )**  
(Hotpoint appliances)

## COMPOSIZIONE L 420

COMPOSITION W 420

### COMPONENTI COMPONENTS

**Colonna 60 H 217 frigo-freezer 315 classe A+**

60 cm column H 217 fridge-freezer 315 class "A+"

**Colonna 60 H 217 forno multifunzione inox**

60 cm column H 217 for stainless steel multifunctional oven

**Base 60**

60 cm base unit

**Piano cottura 75 5 gas inox con valvola**

75 cm stainless steel hob with 5 burners with safety valve

**Base 90 2 cassetti e cestone predisposta piano cottura**

90 cm base unit with 2 drawers and deep drawers configured for hob

**Base 60**

60 cm base unit

**Sottolavello 90**

90 cm sink unit

**Lavello ad incasso 86 x 50 1 vasca inox**

86x50 cm built-in sink with 1 stainless steel bowl

**Top 300 P 61 in laminato H 4**

300 cm laminate worktop D 61 H 4

**Pensile 60 H 72**

60 cm wall unit H 72

**Cappa 90 "STILO" inox**

90 cm "STILO" stainless steel hood

**Pensile 60 H 72**

60 cm wall unit H 72

**Scolapiatti 90 H 72**

90 cm plate rack H 72

**Asta appendipensili ml 4**

4 lm wall unit fixing strip

**(Elettrodomestici Hotpoint)**  
(Hotpoint appliances)